

# Electrohydraulic pumps

**RE 10 104/12.12**  
Replaces:  
RE 10 104/03.10

1/70

## EHP

Nominal voltage (DC): 12...110 V  
Size of pump: 1.0...22.5 cm<sup>3</sup>/rev



## Table of contents

---

Content	Page
Ordering code	2
Program overview	4
Technical data	5
Project planning notes	6
Commissioning	7
Unit dimensions	8...62
Characteristics	9...63
Accessories, spare parts	64...65
Project specifications	66...69

## Features

---

The staged modular principle means that electric motor and pump can be combined according to the required performance, guaranteeing:

- high efficiency
- low noise
- high operating pressure
- compact dimensions
- long service life
- consistent quality

### Application areas

As drive groups in vehicles, they are employed primarily for the lifting and steering functions.

# Ordering code

## Electro-hydraulic single pump

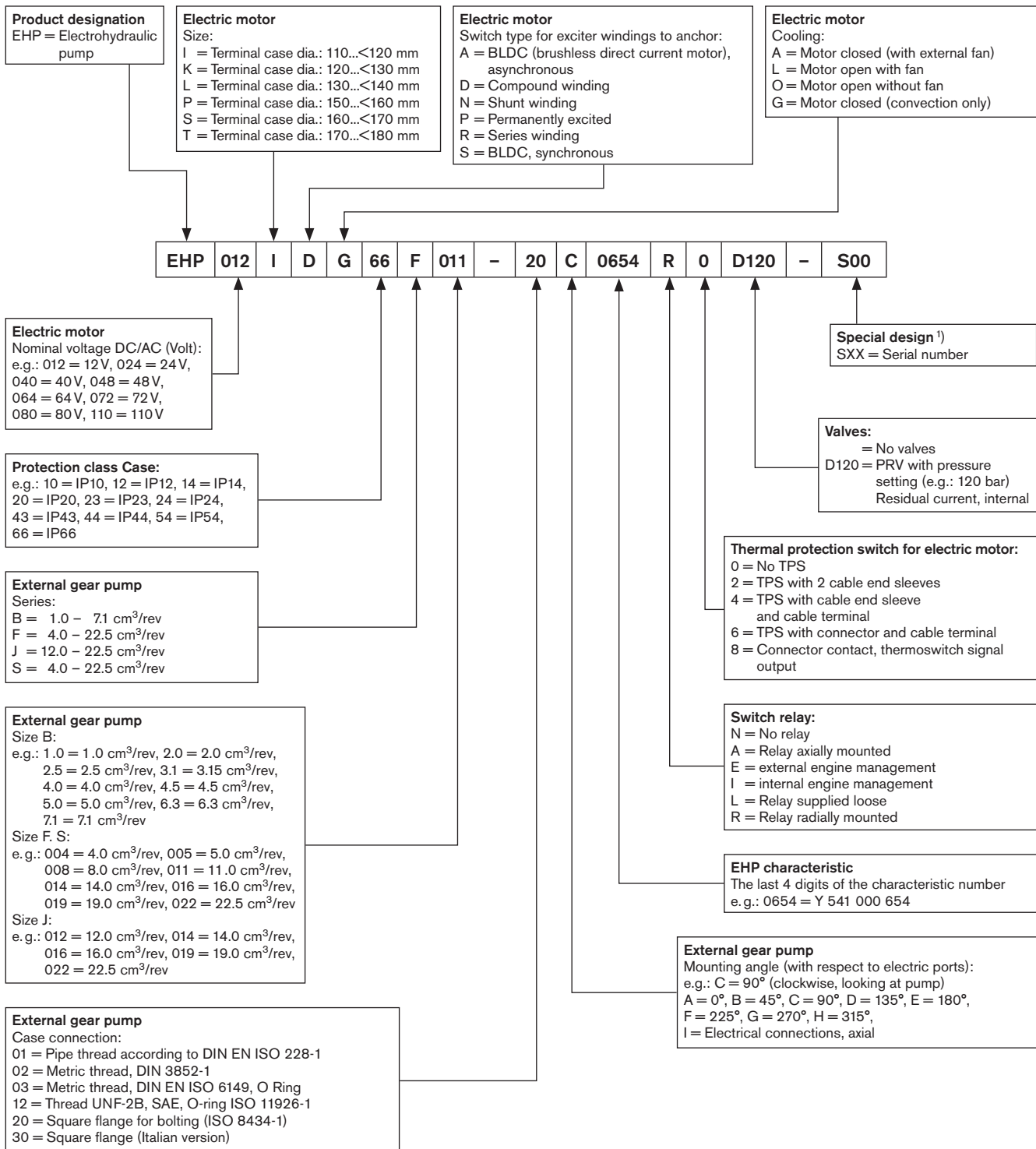

<sup>1)</sup> In case of deviation from the standard version (for front/end cover and line connections), additional identification shall be provided in the form of a special number.

# Ordering code

## Electrohydraulic multiple pump

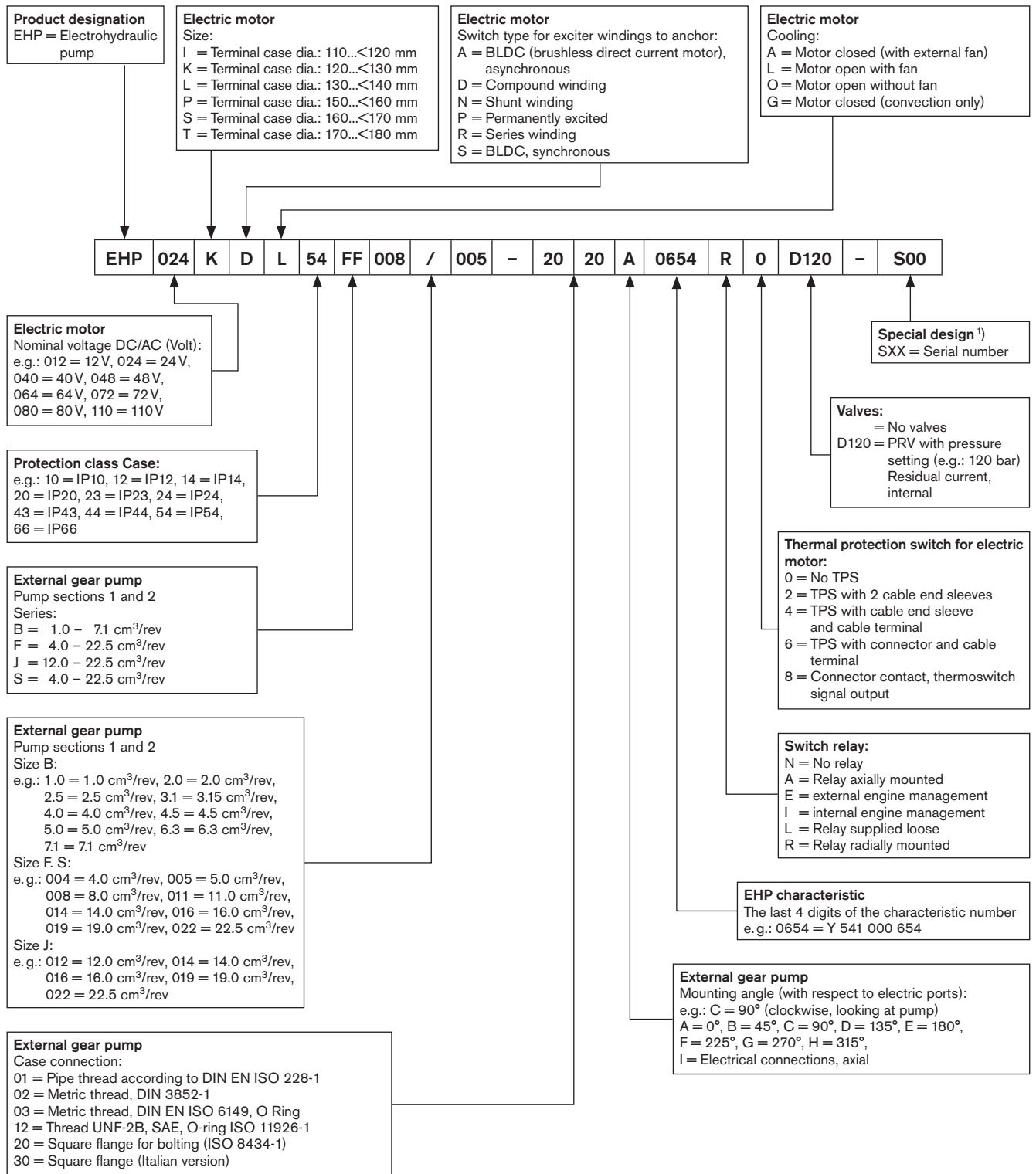

<sup>1)</sup> In case of deviation from the standard version (for front/end cover and line connections), additional identification shall be provided in the form of a special number.

## Program overview

Part number	Page	Characteristic	Quotation drawing	Ordering code
<b>0 541 200 082</b>	8	Y 541 001 049	A 541 020 330	EHP12IDG54F004-20E1049A0D040
<b>0 541 000 026</b>	10	Y 541 001 414	A 541 110 111	EHP12IDG66B1.0-02A0414N0
<b>0 541 100 075</b>	10	Y 541 000 416	A 541 110 111	EHP12IDG66B3.0-02A0416N0
<b>0 541 000 024</b>	14	Y 541 001 015	A 541 110 190	EHP24IDG54B1.0-02A1015L4
<b>0 541 100 070</b>	14	Y 541 001 016	A 541 110 190	EHP24IDG54B2.0-02A1016L4
<b>0 541 100 067</b>	12	Y 541 001 018	A 541 110 190	EHP24IDG54B3.0-02A1018N0
<b>0 541 100 071</b>	14	Y 541 001 018	A 541 110 190	EHP24IDG54B3.0-02A1018L4
<b>0 541 100 072</b>	13	Y 541 001 018	A 541 110 190	EHP24IDG54B3.0-02A1018R0
<b>0 541 100 074</b>	14	Y 541 001 018	A 541 110 190	EHP24IDG54B3.0-02A1018N2
<b>0 541 200 063</b>	16	Y 541 000 388	A 541 020 083	EHP24IDG43F004-20A0388N0
<b>0 541 300 057</b>	18	Y 541 000 402	A 541 020 085	EHP24IDG54F005-20A0402N6
<b>0 541 300 081</b>	20	Y 541 001 042	A 541 020 305	EHP24IDG54F005-20A1042A6
<b>0 541 400 065</b>	20	Y 541 001 043	A 541 020 305	EHP24IDG54F008-20A1043N0
<b>0 541 100 046</b>	22	Y 541 000 406	A 541 110 101	EHP24IDG43B2.0-02A0406N0
<b>0 541 100 052</b>	24	Y 541 000 902	A 541 110 130	EHP24IDL12B3.0-20C0902N0
<b>0 541 100 053</b>		Y 541 000 903	A 541 110 130	EHP24IDL12B3.8-20C0903N0
<b>0 541 200 068</b>	26	Y 541 000 904	A 541 110 154	EHP24IDL12B4.6-20A0904N0
<b>0 541 100 058</b>	28	Y 541 000 902	A 541 110 162	EHP24IDL12B3.0-02A0902N0
<b>0 541 500 071</b>	30	Y 541 000 656	A 541 023 062	EHP24KDG66F011-12A0656N0D060
<b>0 541 500 078</b>	32	Y 541 000 656	A 541 023 066	EHP24KDG66F011-20A0656L0D050
<b>0 541 300 058</b>	34	Y 541 001 096	A 541 026 001	EHP24KDL20FB005/1.0-2002A0096N0
<b>0 541 100 055</b>	36	Y 541 000 611	A 541 114 010	EHP24KDG43B3.0-02A0611N0
<b>0 541 200 067</b>	38	Y 541 000 613	A 541 114 014	EHP24KDG43B4.6-20C0613N0
<b>0 541 100 054</b>	40	Y 541 000 612	A 541 114 016	EHP24KDG43B3.8-20C0612N0
<b>0 541 200 083</b>	42	Y 541 001 325	A 541 021 351	EHP24PRL20F004-20E1325N0
<b>0 541 300 068</b>		Y 541 001 326	A 541 021 351	EHP24PRL20F005-20E1326N0
<b>0 541 400 075</b>		Y 541 001 327	A 541 021 351	EHP24PRL20F008-20E1327N0
<b>0 541 500 082</b>		Y 541 001 328	A 541 021 351	EHP24PRL24F011-20E1328N0
<b>0 541 600 043</b>		Y 541 001 338	A 541 021 351	EHP24PRL24F016-20E1338N0
<b>0 541 400 079</b>		Y 541 001 327	A 541 021 367	EHP24PRL20F008-20C1327N0
<b>0 541 400 083</b>	48	Y 541 001 327	A 541 021 383	EHP24PRL20F008-01E1327N0
<b>0 541 400 077</b>	48	Y 541 001 335	A 541 021 358	EHP24PRL20S008-20E1335N0
<b>0 541 500 083</b>	48	Y 541 001 337	A 541 021 358	EHP24PRL20S011-20E1337N0
<b>0 541 400 082</b>	50	Y 541 001 335	A 541 021 382	EHP24PRL24S008-20G1335N0
<b>0 541 300 069</b>	52	Y 541 001 324	A 541 021 357	EHP24PRL20FB005/3.0-2002E1324N0
<b>0 541 300 074</b>	54	Y 541 001 341	A 541 021 368	EHP48PRL20F005-20E1341N0
<b>0 541 400 080</b>	54	Y 541 001 344	A 541 021 368	EHP48PRL20F008-20E1344N0
<b>0 541 300 079</b>	56	Y 541 001 341	A 541 021 379	EHP48PRL20F005-20A1341N0
<b>0 541 400 078</b>	58	Y 541 001 339	A 541 021 366	EHP48PRL20S008-20C1339N0
<b>0 541 500 074</b>	60	Y 541 001 173	A 541 022 166	EHP48SDL14S011-20A1173N0
<b>0 541 300 032</b>	62	Y 541 001 003	A 541 023 013	EHP72KDO14F005-20A1003N0

Other versions on request.

**Technical data****General**

Installation position	Vertical, hydraulic pump at bottom; horizontal as shown in dimensions drawing. Condensation opening, if fitted, at bottom
Ambient temperature range	between -25 °C and +60 °C
Mounting	Saddle mounting with wire tie

**Pump**

Design	External gear pump				
Type	AZPB...	AZPF...	AZPJ...	AZPS...	
Displacement	cm <sup>3</sup> /rev	1.0 – 7.1	4.0 – 22.5	12.0 – 22.5	4.0 – 22.5
Suction pressure	bar	min. 0.7 max. 3 (absolute)			
max. continuous pressure $p_1^{**}$		200 – 250	180 – 250	250	220 – 250
max. intermittent pressure $p_2^{**}$		230 – 280	210 – 280	280	250 – 280
max. peak pressure $p_3^{**}$		250 – 300	230 – 300	300	290 – 300
Line ports	AZPB/F/S: Thread, flange, others on request				
Fluids	<ul style="list-style-type: none"> <li>- Mineral oil compliant with DIN 51524, 1–3, however under higher load at least HLP compliant with DIN 51524 Part 2 recommended.</li> <li>- Comply with RE 90220</li> <li>- Further operating fluids possible after consultation</li> </ul>				
Viscosity	12 ... 800 mm <sup>2</sup> /s permitted range 20 ... 100 mm <sup>2</sup> /s recommended range ... 2000 mm <sup>2</sup> /s permitted for start up				
Temperature of hydraulic fluid	-25 ... +80 °C				
Filtration *)	At least cleanliness level 21/18/15 compliant with ISO 4406 (1999)				

**Electric motor**

Design	DC motor with compound or series winding					
Size (code)	I	K	L	P	S	T
Terminal case Ø mm	110 ... < 120	120 ... < 130	130 ... < 140	150 ... < 160	160 ... < 170	170 ... < 180
Voltage (volts)	12, 24, 40, 48, 72, 80 see overview of range					
Power output (kW)	1.5 ... 8.1, other outputs on request					
Protection class	see Program overview					
<b>Diagrams</b>	These are valid for operation under the following conditions: Ambient temperature +20 °C Electrolyte temperature +20 °C Motor temperature +20 °C Oil temperature +50 °C Viscosity $\nu = 32$ mm <sup>2</sup> /s S2, S3 see VDE 0530					

**Relay** (not available in every version)

Voltage	12 V	24 V
Exciter current	1.5 A	0.9 A
Contact current at S3 = 12 %	350 A	
Contact current, continuous	150 A	
Protection class	IP54 / IP6K9K / IP66 auf Anfrage	

\*\*) On hydraulic systems or devices with critical counter-reaction, such as steering valves, brake valves, the type of filtration selected must be adapted to the sensitivity of these devices/systems.

Safety requirements pertaining to the whole systems are to be observed.

Please contact us with respect to applications with high numbers of load cycles.

\*\*) Detailed information, see series B: RE10087

F: RE10089

J: RE10094

S: RE10095

# Project planning notes

## 1. Operating modes

The starting points for dimensioning electrohydraulic pump are pressure  $p$  and flow rate  $Q$ . However, the resulting power output  $P$  depends on the **operating mode**. Here, a distinction is made between:

### Continuous operation S 1

Operation with constant load, with a duration long enough for thermal equilibrium to be reached.

### Short-term operation S 2

Operation with constant load. Of short duration so that thermal equilibrium is not reached. Example: S 2–60 min.

### Intermittent operation S 3

Operation comprising a series of similar cycles (cycle duration 10 min), which include a time with constant load and a pause. Example: S 3–10%

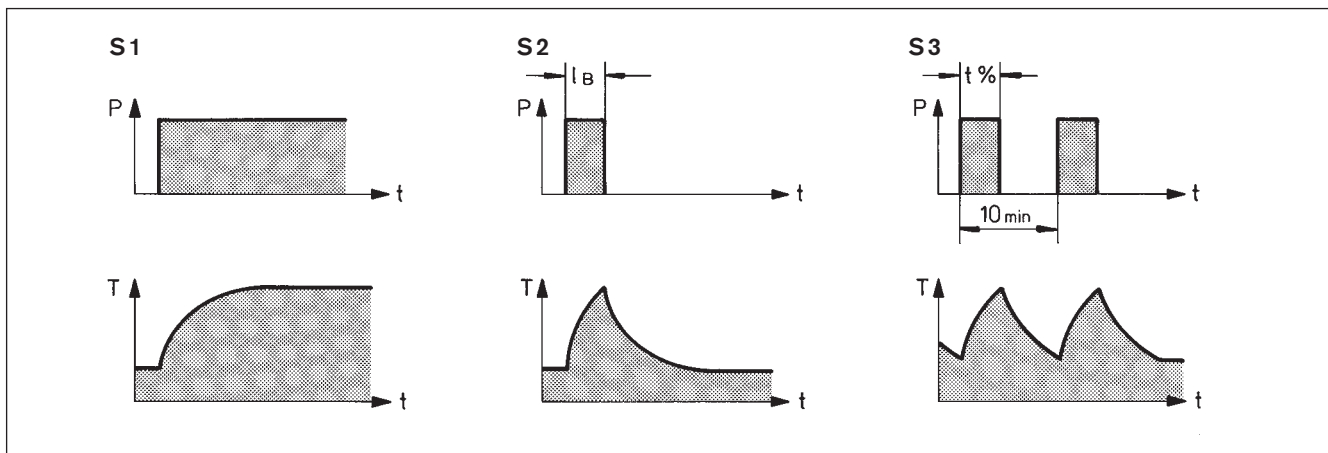

## 2. Motor characteristics

Speed and torque of a DC motor and thus the flow rate and pressure of the pump being driven are interdependent in accordance with the curves shown. The curve is determined by both the power output and the type of winding. A distinction is made between:

### Shunt winding

Benefit: Small change in speed with load fluctuation.  
Drawback: Low start-up torque, current peaks.

### Series winding

Benefit: High start-up torque  
Drawback: "Motor overspeeding" without load

### Compound winding

Compromise between shunt and series winding.

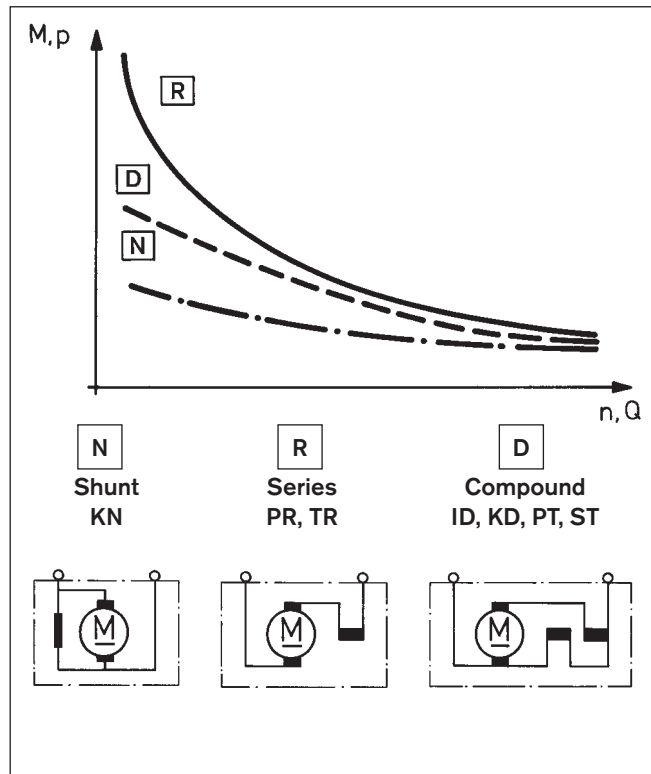

## Project planning notes (continued)

### 3. Selection

It is not the power output figure (in watts) that is decisive for the selection, but rather the actuated time under the required operating conditions, see Characteristics. This prevents the motor from being either overloaded or dimensioned too large. It is expedient to select a suitable electrohydraulic pump on the basis of the diagrams for the different combinations. These show:

a) the flow rate  $Q$  (l/min) and the electric current consumption  $I$  (A) depending on pressure  $p$ .

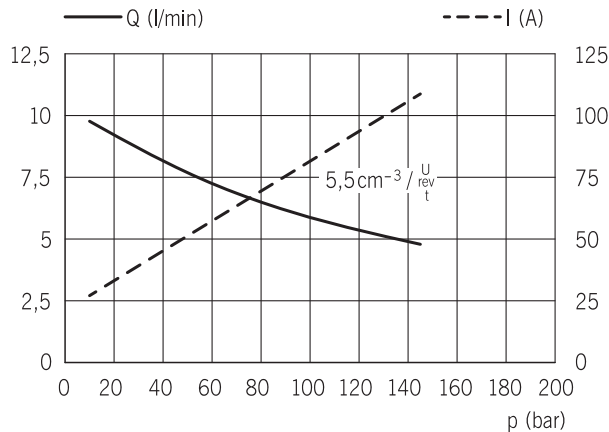

b) the permissible pressure  $p$  depending on the operating mode S3 (%) or S2 (min).

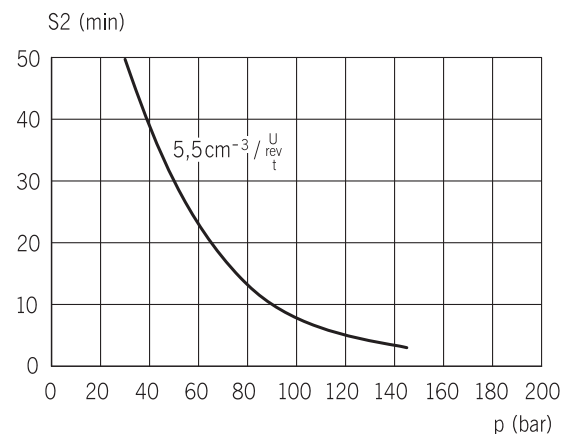
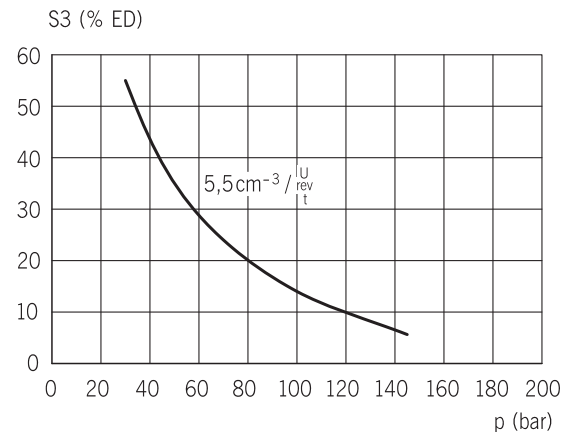

### Commissioning

#### Installation and commissioning

- Fill pump with hydraulic fluid before installation.
- Pipelines to be cleaned of dirt, cinders, sand, chips etc. before installation.  
Pipes, in particular must be pickled or rinsed.
- Before the 1st commissioning, the overall hydraulic system is to be carefully vented.
- Cover up the radial lip-type shaft seal ring and the air vents when spraying and painting.
- Observe characteristics, in particular, speeds and pressures as well as negative pressure in the suction line.

You can find further information in our publication:  
"General Operating Instructions for External Gear Units"  
RE 07 012-B1.

#### Filter recommendation

We recommend that a full-flow filter always be used.

#### Electrical installation

Dimension the line cross section in accordance with the maximum current.

Polarity without influence on the direction of rotation.

Note the protection class and environmental conditions.

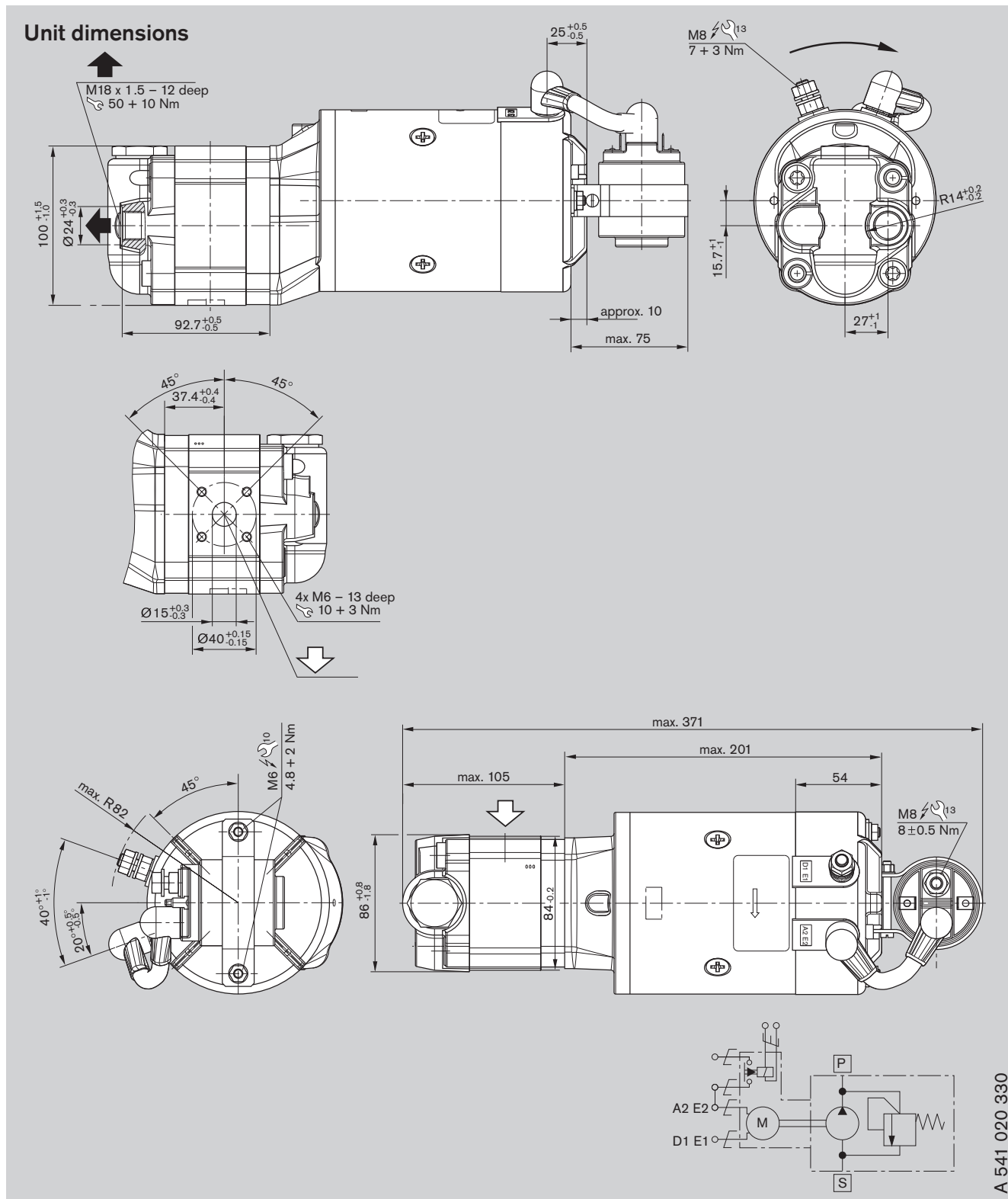

A 541 020 330

Type of protection:

Motor case IP 54

Ports IP 00

Ordering code	Displacement V [cm <sup>3</sup> /rev]	Dimension [mm]			PRV [bar]	Weight [kg]	Part number
		A	B	C			
EHP12IDG54F004-20E1049A0D040	4	-	-	-	40 <sup>+5</sup>	2.7	<b>0 541 200 082</b>



**Characteristics  
for A 541 020 330**

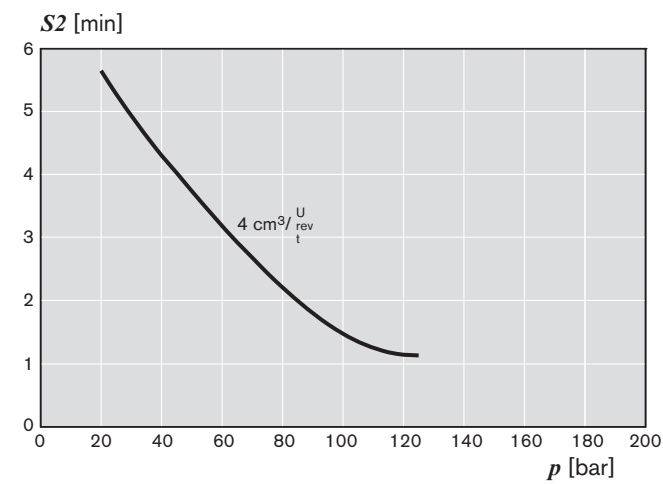
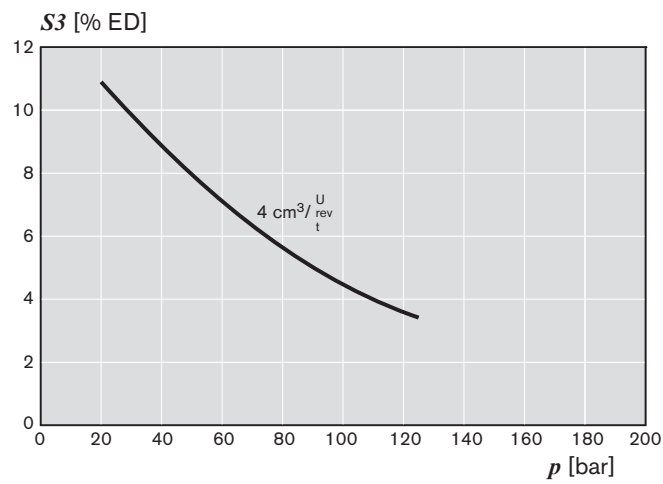
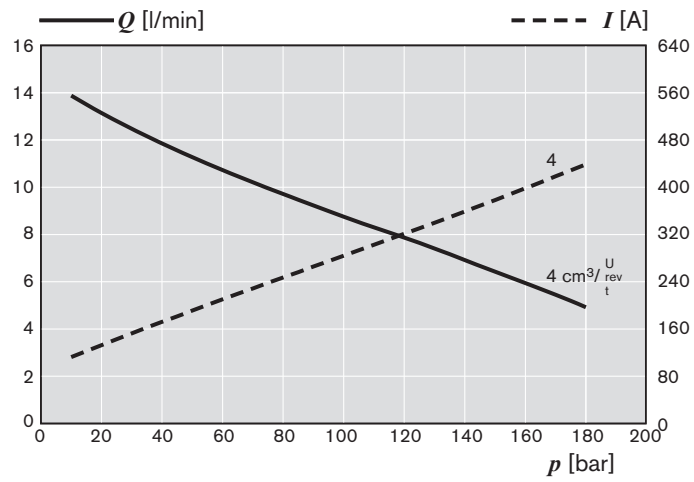

Unit dimensions

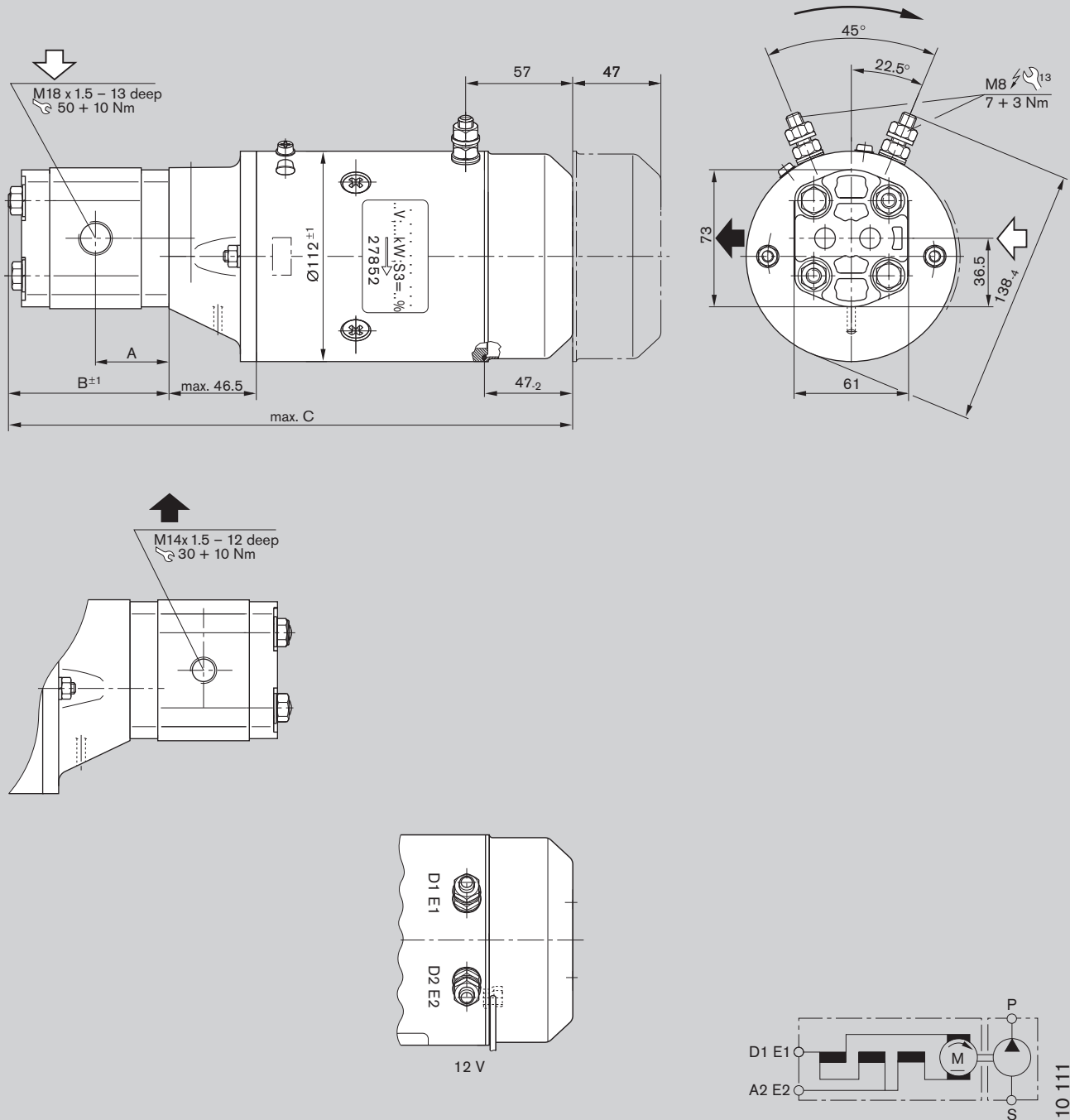

A 541 110 111

Type of protection:

Motor case IP 66

Ports IP 00

Ordering code	Displacement $V$ [cm <sup>3</sup> /rev]	Dimension [mm]			Weight [kg]	Part number
		A	B	C		
EHP12IDG66B1.0-02A0414N0	1.0	35.0	76	292	8.5	<b>0 541 000 026</b>
EHP12IDG66B3.0-02A0416N0	3.0	39.2	86	302	8.5	<b>0 541 100 075</b>

**Characteristics  
for A 541 110 111**

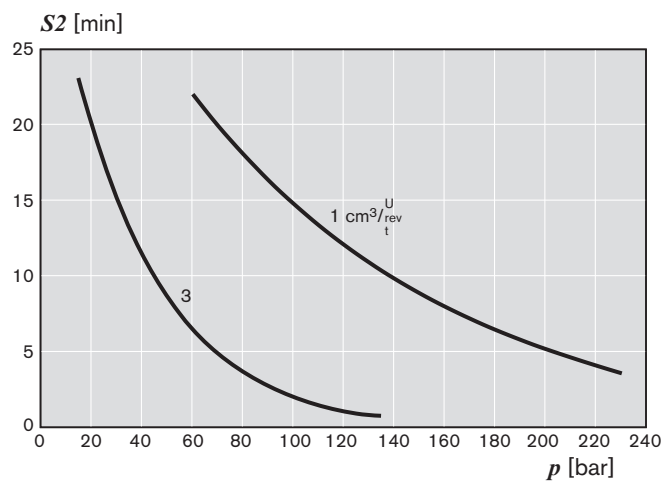
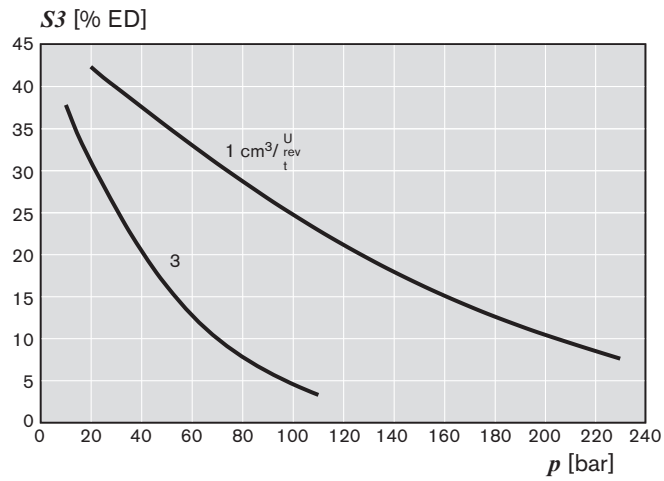
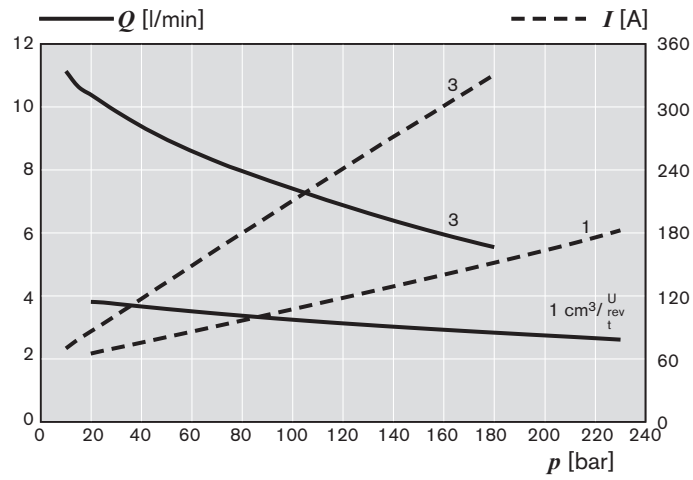

Unit dimensions

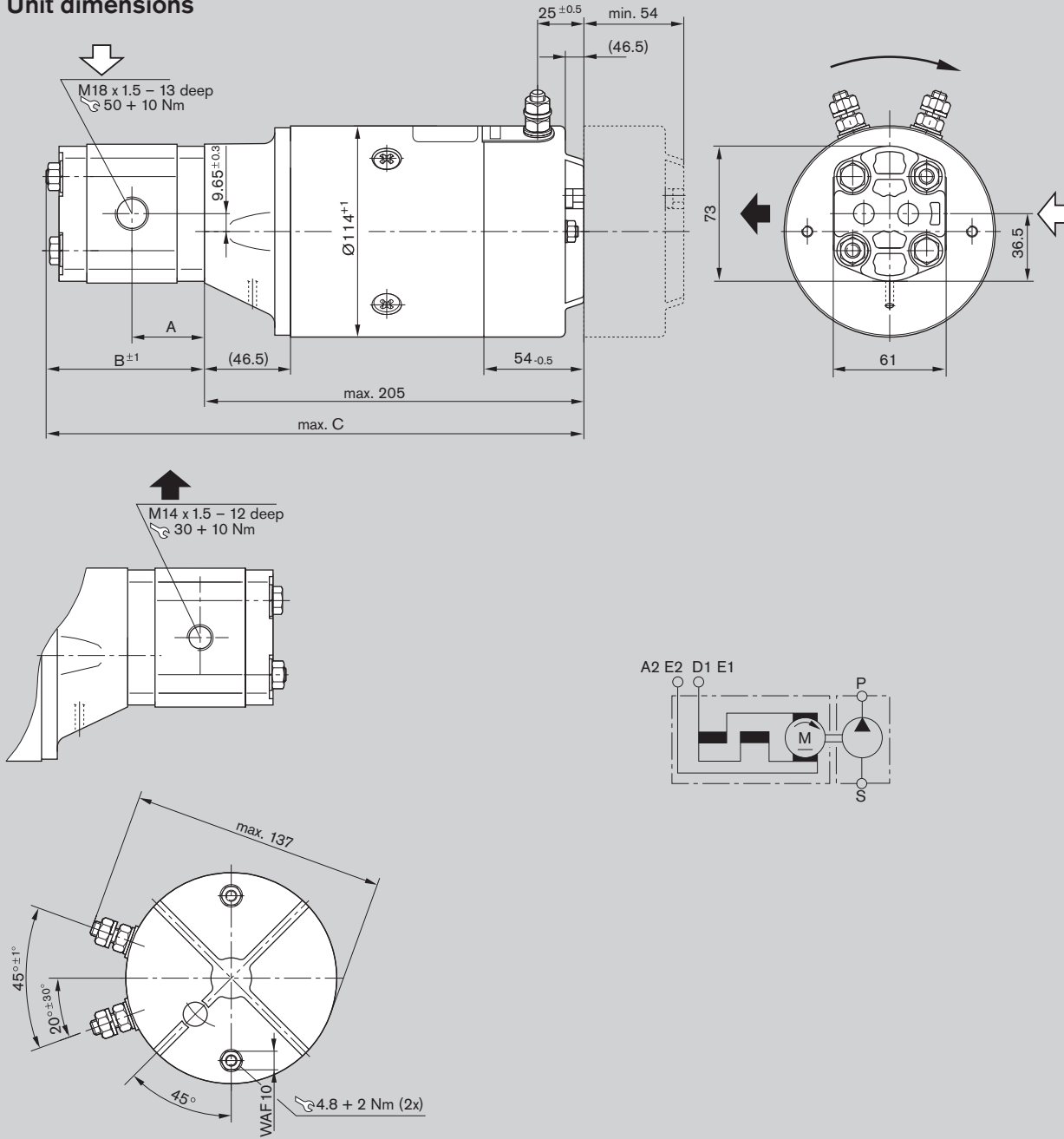

A 541 110 190\_1

Type of protection:

Motor case IP 54

Ports IP 00

Ordering code	Displacement V [cm³/rev]	Dimension [mm]			TPS*)	Relay mounted	Relay loose	Weight [kg]	Part number
		A	B	C					
EHP24IDG54B3.0-02A1018N0	3.0	39.2	86	292	-	-	8.7	<b>0 541 100 067</b>	

\*) Thermal protection switch

Unit dimensions

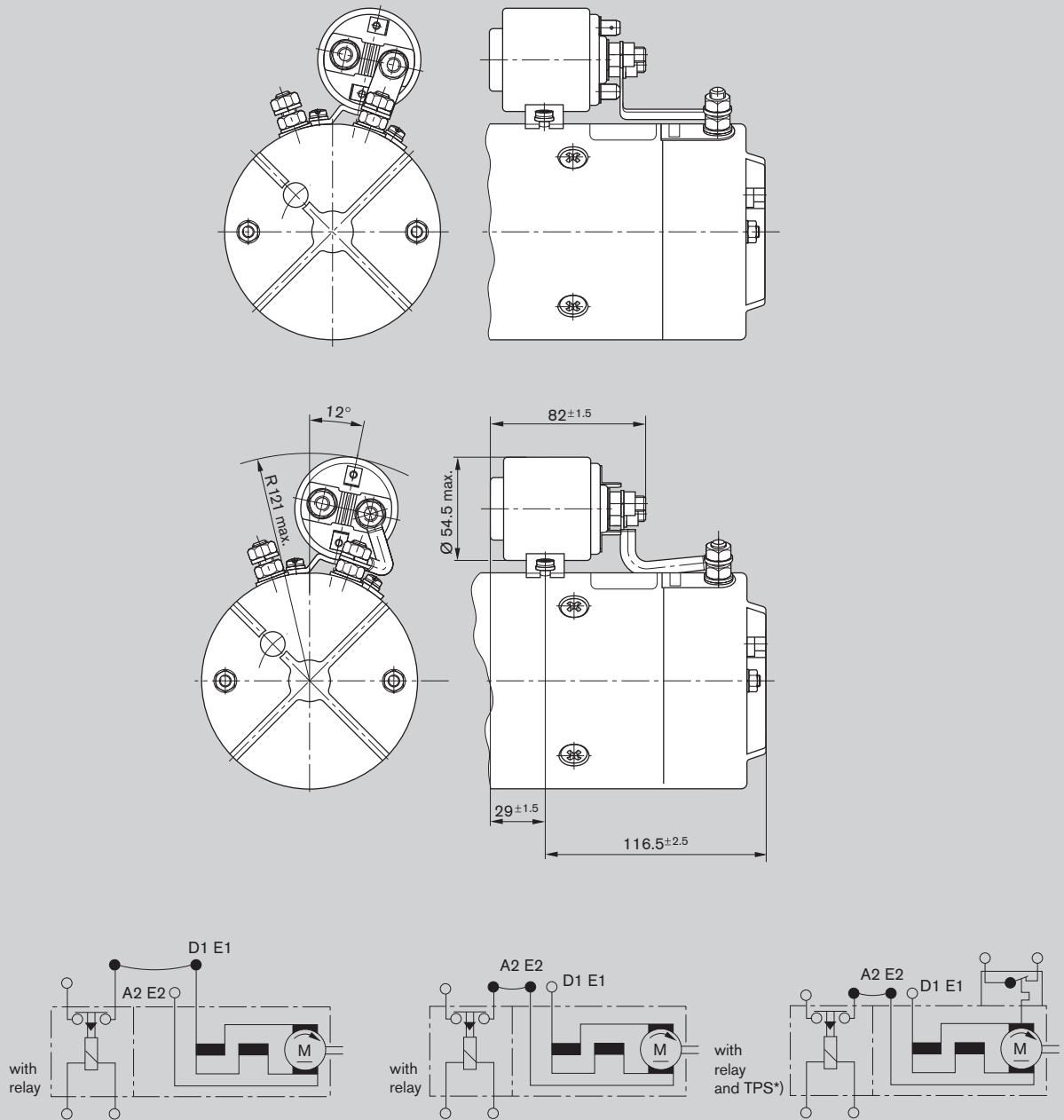

A 541 110 190\_2

Type of protection:

Motor case IP 54

Ports IP 00

Ordering code	Displacement <i>V</i> [cm <sup>3</sup> /rev]	Dimension [mm]			TPS *)	Relay mounted	Relay loose	Weight [kg]	Part number
		A	B	C					
EHP24IDG54B3.0-02A1018R0	3.0	39	86	292	-	x		9.4	<b>0 541 100 072</b>

\*) Thermal protection switch

Unit dimensions

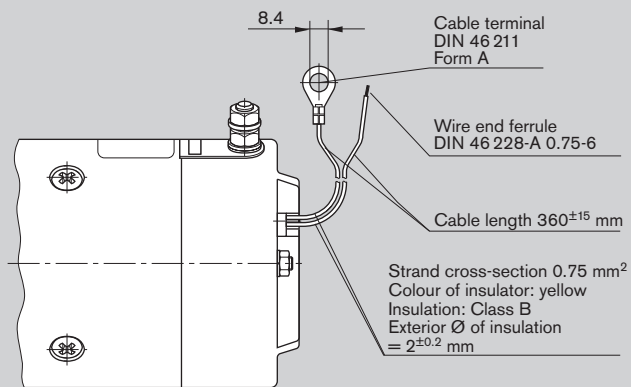
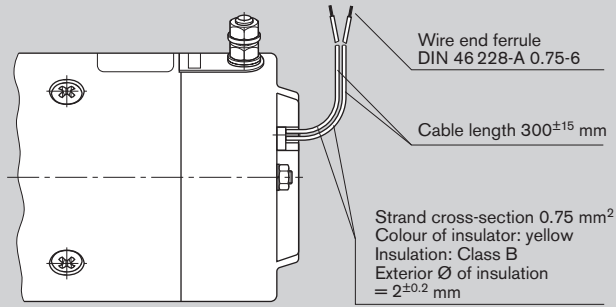
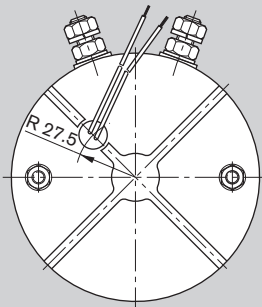

TPS contacts\*)

$I_{Nom} = 2.5 A$   
(max. 5 A / 250 V)

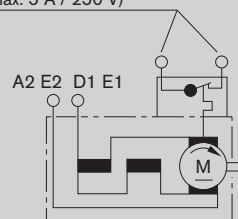

A 541 110 190\_3

Type of protection:

Motor case IP 54

Ports IP 00

Ordering code	Displacement $V [cm^3/rev]$	Dimension [mm]			TPS*)	Relay mounted	Relay loose	Weight [kg]	Part number
		A	B	C					
EHP24IDG54B1.0-02A1015L4	1.0	35.0	76.0	282	x	-	1 547 211 007	8.4	<b>0 541 000 024</b>
EHP24IDG54B2.0-02A1016L4	2.0	37.1	81.0	287	x	-	1 547 211 007	8.5	<b>0 541 100 070</b>
EHP24IDG54B3.0-02A1018L4	3.0	39.0	86.0	292	x	-	1 547 211 007	8.7	<b>0 541 100 071</b>
EHP24IDG54B3.0-02A1018N2	3.0	39.2	86.0	292	x	-		8.7	<b>0 541 100 074</b>

\*) Thermal protection switch

**Characteristics  
for A 541 110 190**

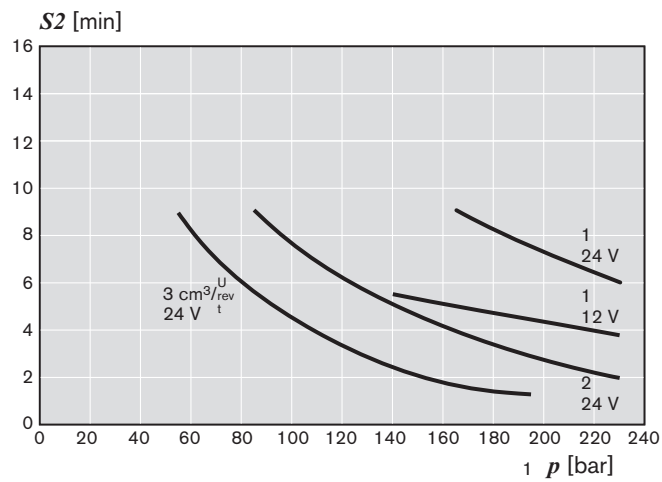
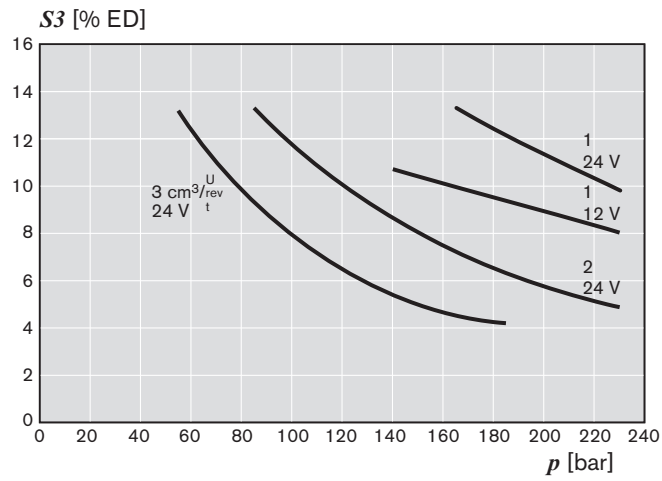
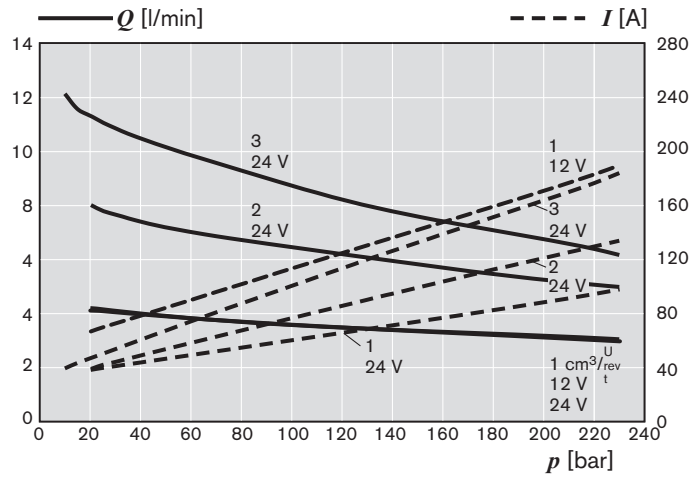

Unit dimensions

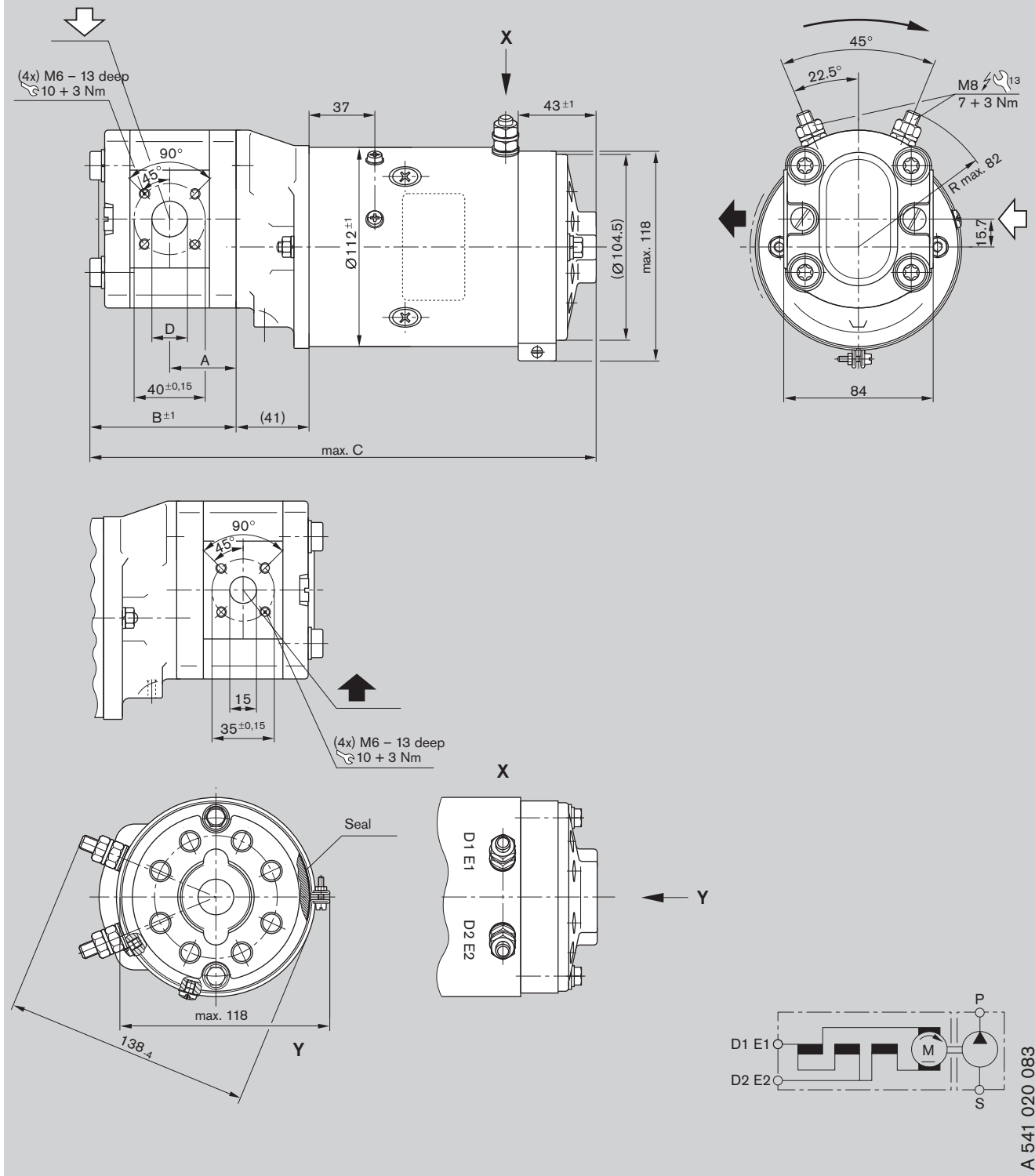

A 541 020 083

Type of protection:

Motor case IP 43

Ports IP 00

Ordering code	Displacement V [cm <sup>3</sup> /rev]	Dimension [mm]				Weight [kg]	Part number
		A	B	C	D		
EHP24IDG43F004-20A0388N0	4.0	37.3	82.5	293.5	15.0	10.0	<b>0 541 200 063</b>



**Characteristics  
for A 541 020 083**

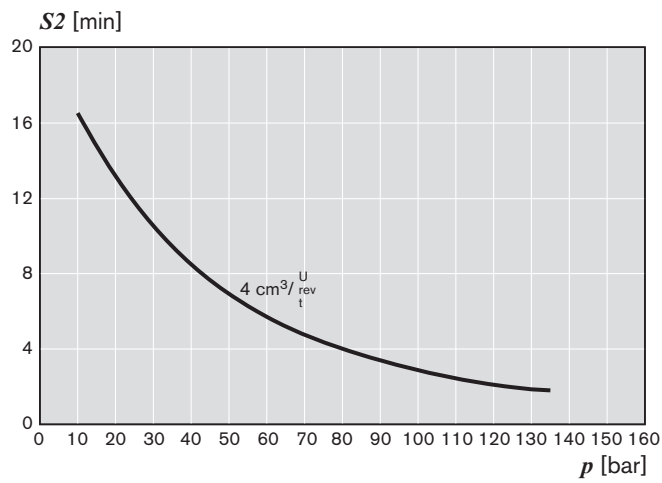
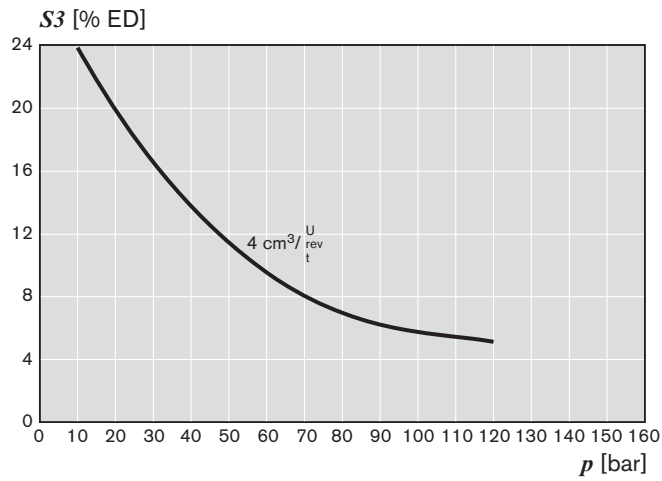
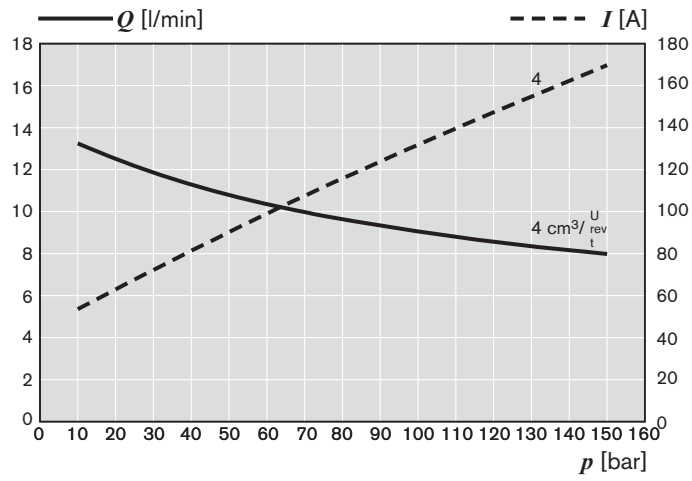

Unit dimensions

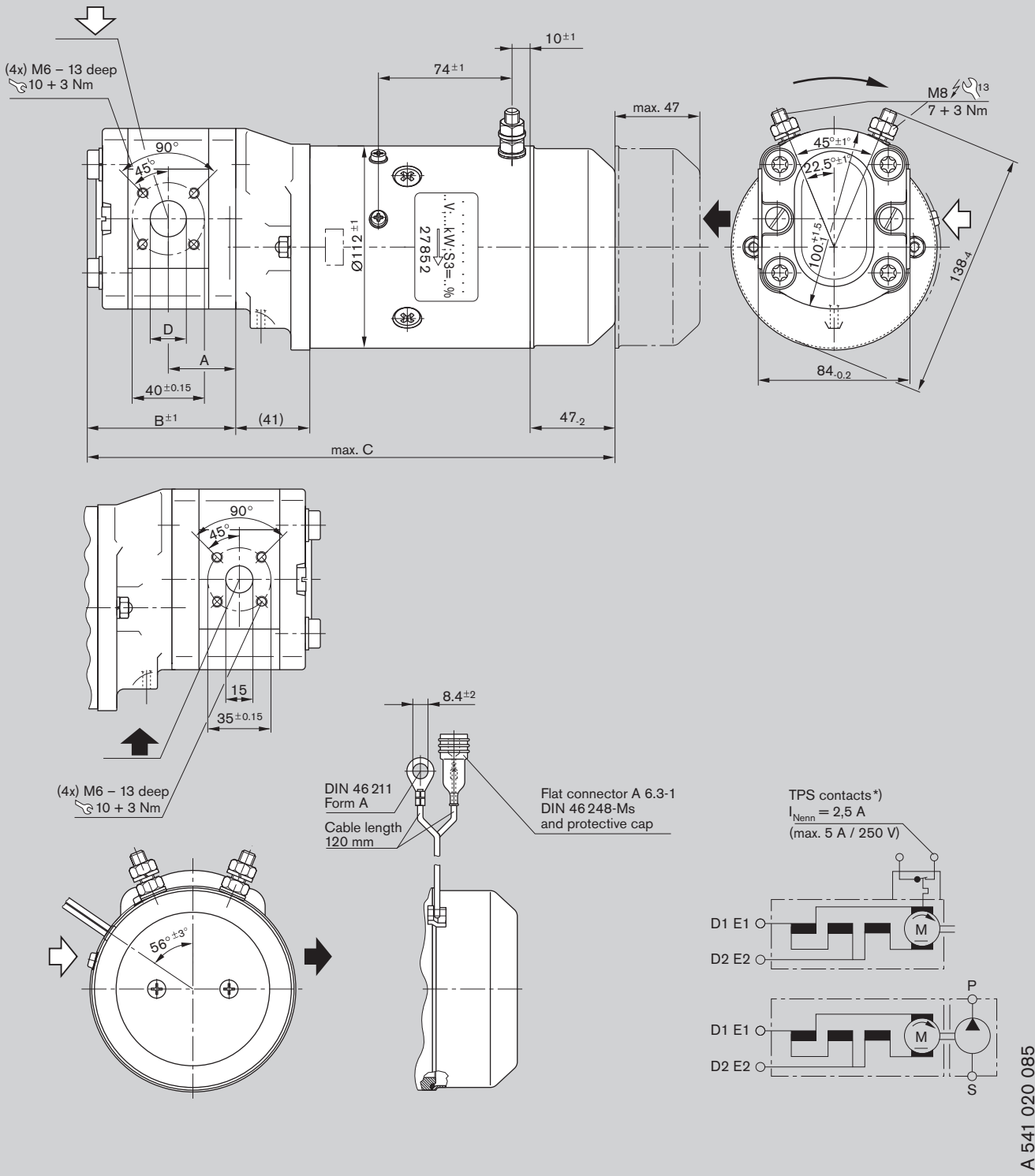

A 541 020 085

Type of protection:

Motor case IP 54

Ports IP 00

Ordering code	Displacement V [cm <sup>3</sup> /rev]	Dimension [mm]				TPS *)	Weight [kg]	Part number
		A	B	C	D			
EHP24IDG54F005-20A0402N6	5.5	38.6	85.0	296.0	15.0	×	10.1	<b>0 541 300 057</b>

\*) Thermal protection switch

**Characteristics  
for A 541 020 085**

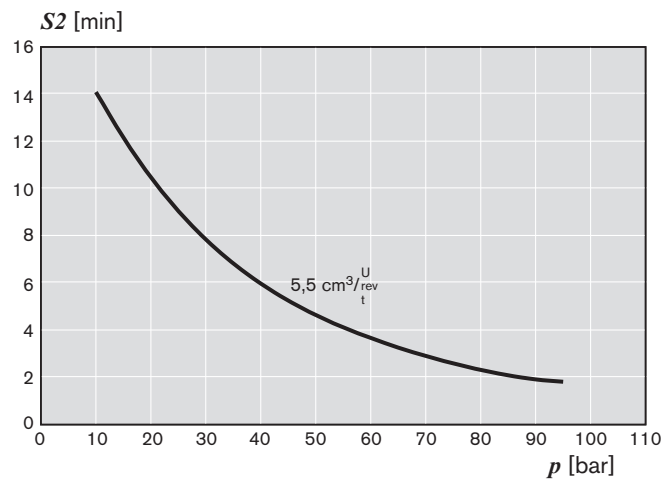
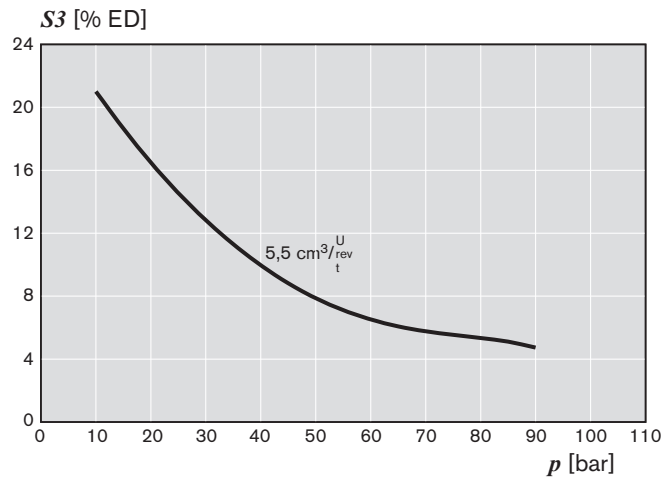
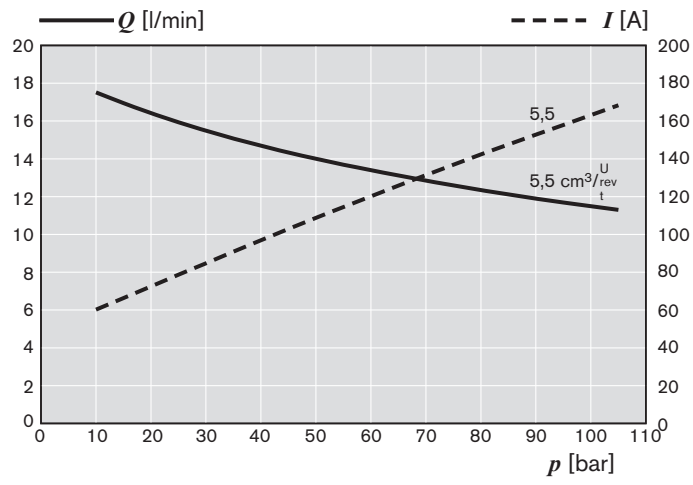

Unit dimensions

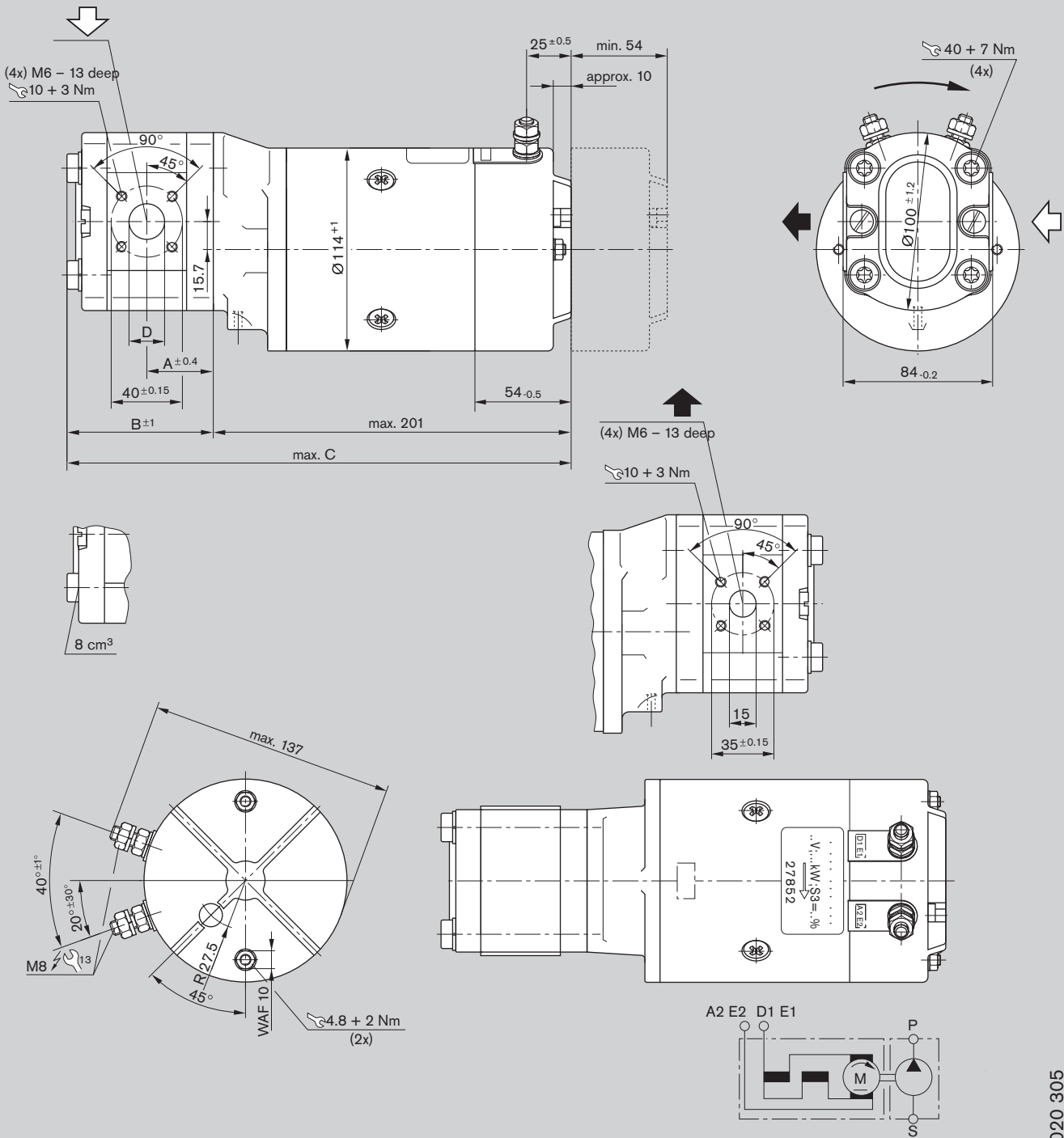

A 541 020 305

Type of protection:

Motor case IP 54

Ports IP 00

Ordering code	Displacement V [cm³/rev]	Dimension [mm]				Weight [kg]	Part number
		A	B	C	D		
EHP24IDG54F005-20A1042A6	5.5	38.6	84.5	286.5	15.0	10.9	<b>0 541 300 081</b>
EHP24IDG54F008-20A1043N0	8.0	40.7	88.6	290.6	20.0	10.4	<b>0 541 400 065</b>

**Characteristics  
for A 541 020 305**

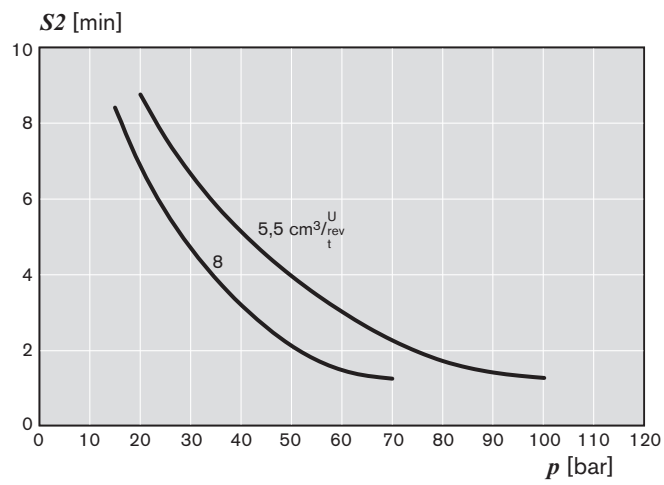
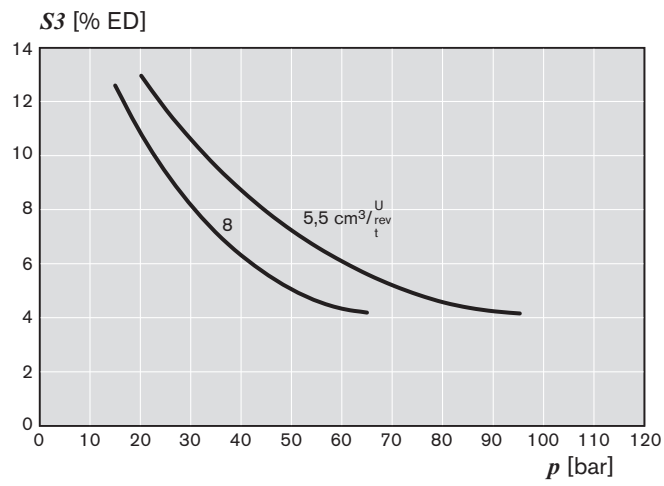
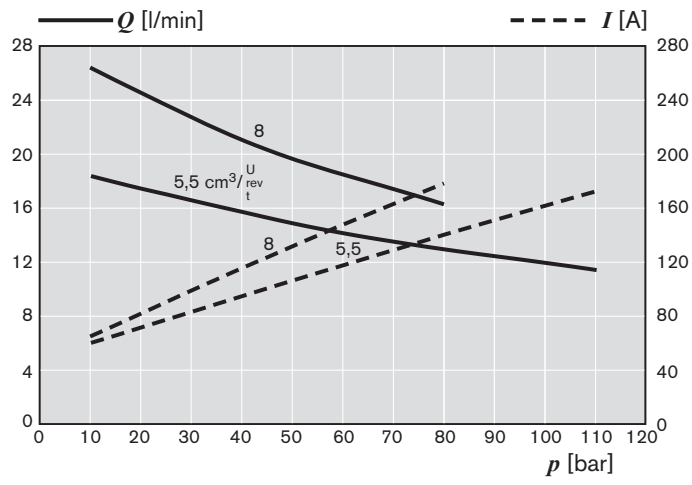

Unit dimensions

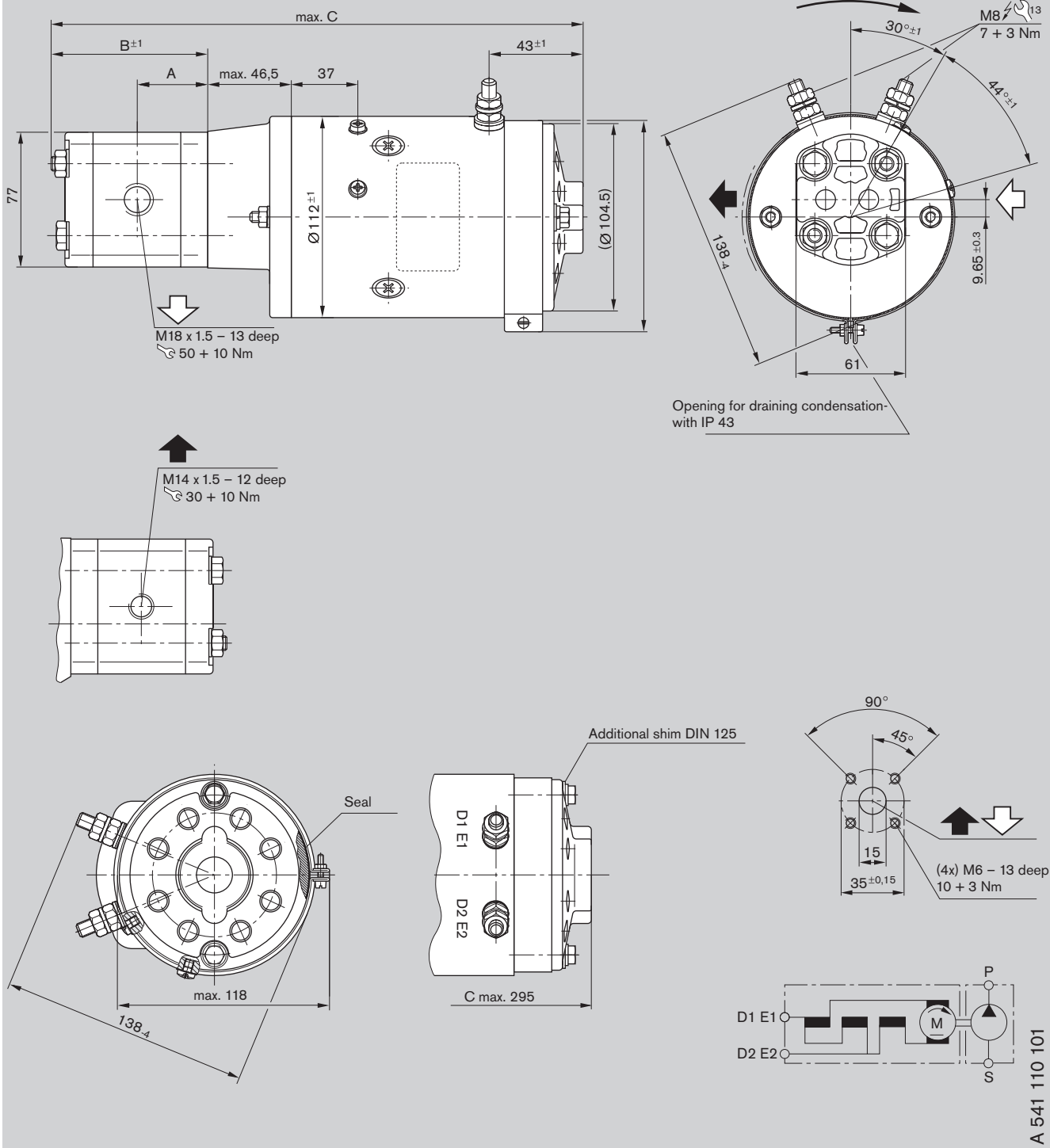

Type of protection:  
 Motor case IP 43  
 Ports IP 00

Ordering code	Displacement V [cm³/rev]	Dimension [mm]			Weight [kg]	Part number
		A	B	C		
EHP24IDG43B2.0-02A0406N0	2.0	37.0	81.0	297.0	9.25	0 541 100 046

**Characteristics  
for A 541 110 101**

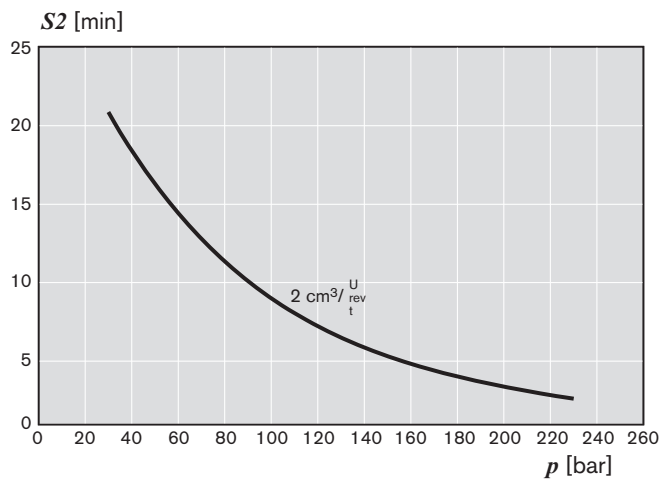
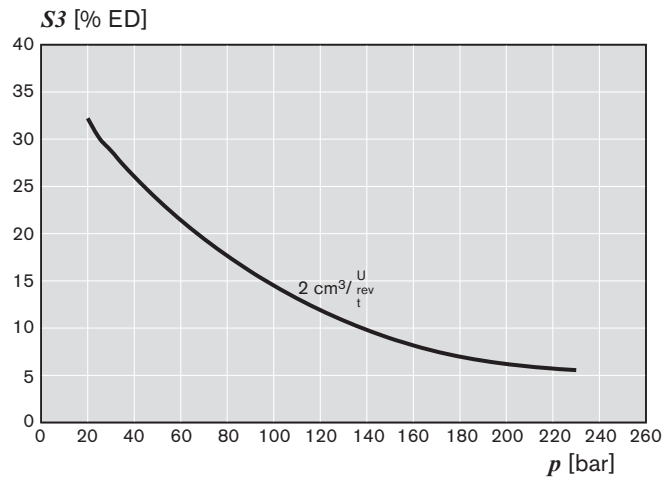
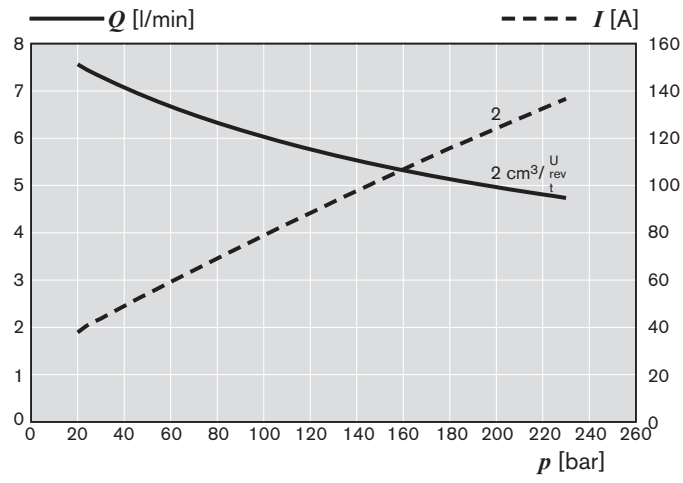

Unit dimensions

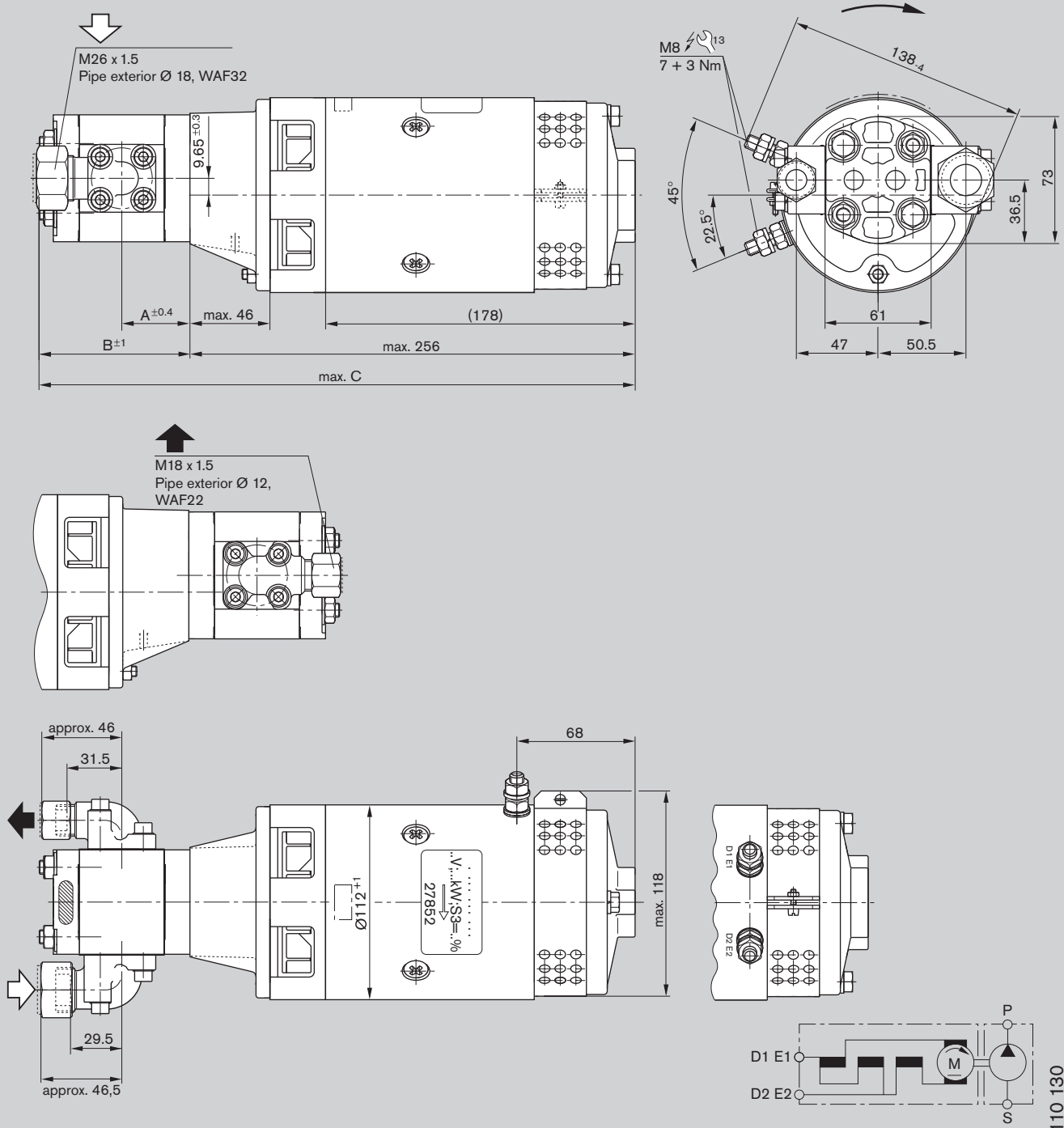

A 541 110 130

Type of protection:

Motor case IP 10

Ports IP 00

Ordering code	Displacement V [cm³/rev]	Dimension [mm]			Weight [kg]	Part number
		A	B	C		
EHP24IDL12B3.0-20C0902N0	3.0	39.2	86.0	343.0	10.5	<b>0 541 100 052</b>
EHP24IDL12B3.8-20C0903N0	3.8	40.7	91.0	348.0	10.6	<b>0 541 100 053</b>



### Characteristics for A 541 110 130

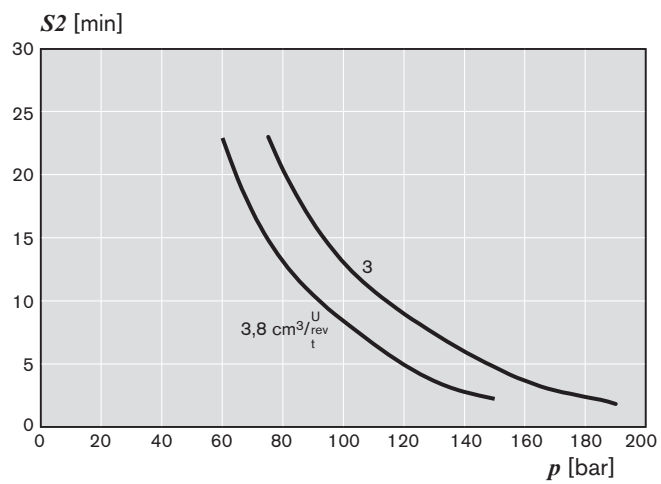
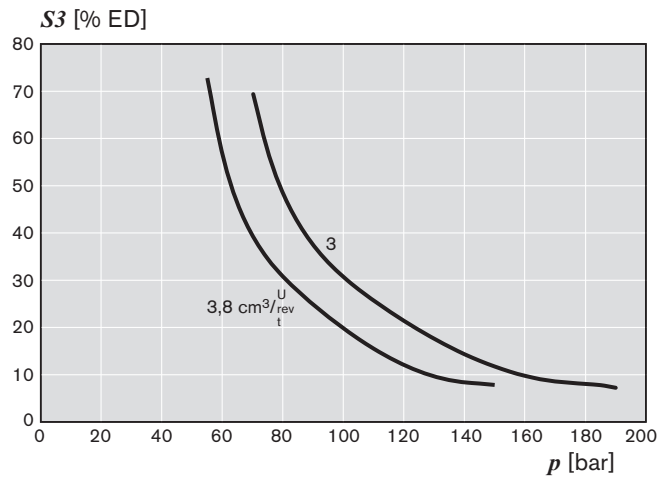
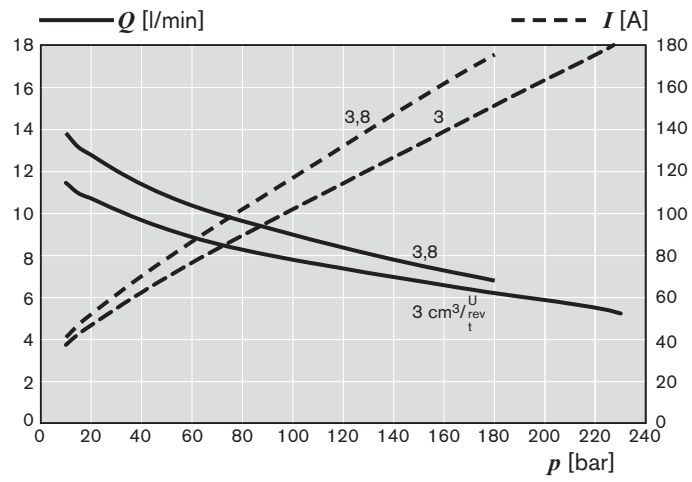

Unit dimensions

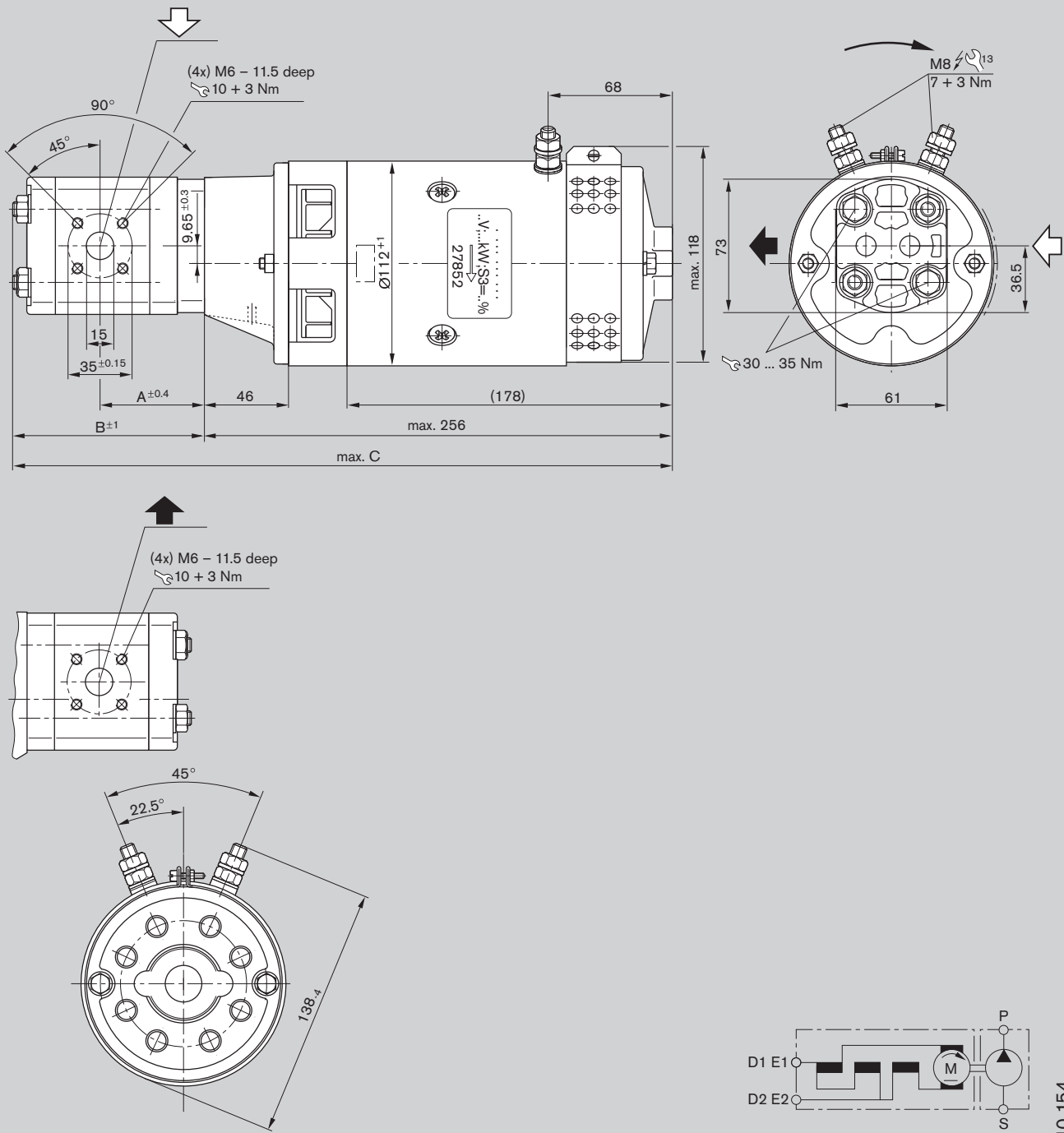

A 541 110 154

Type of protection:

Motor case IP 10  
 Ports IP 00

Ordering code	Displacement V [cm³/rev]	Dimension [mm]			Weight [kg]	Part number
		A	B	C		
EHP24IDL12B4.6-20A0904N0	4.6	42.0	91.0	348.0	10.7	<b>0 541 200 068</b>

**Characteristics  
for A 541 110 154**

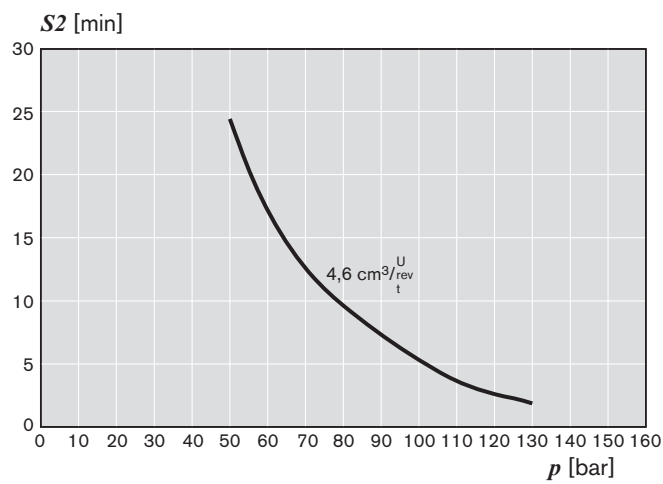
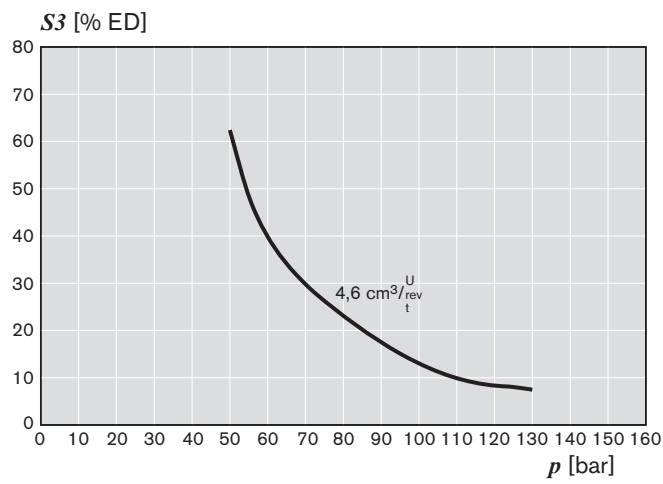
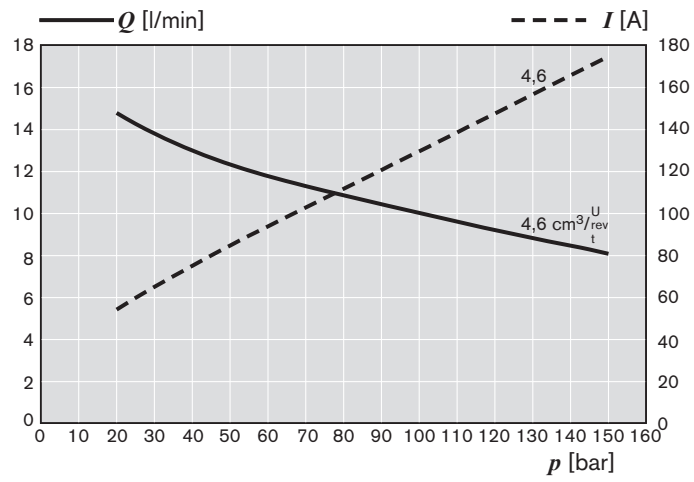

Unit dimensions

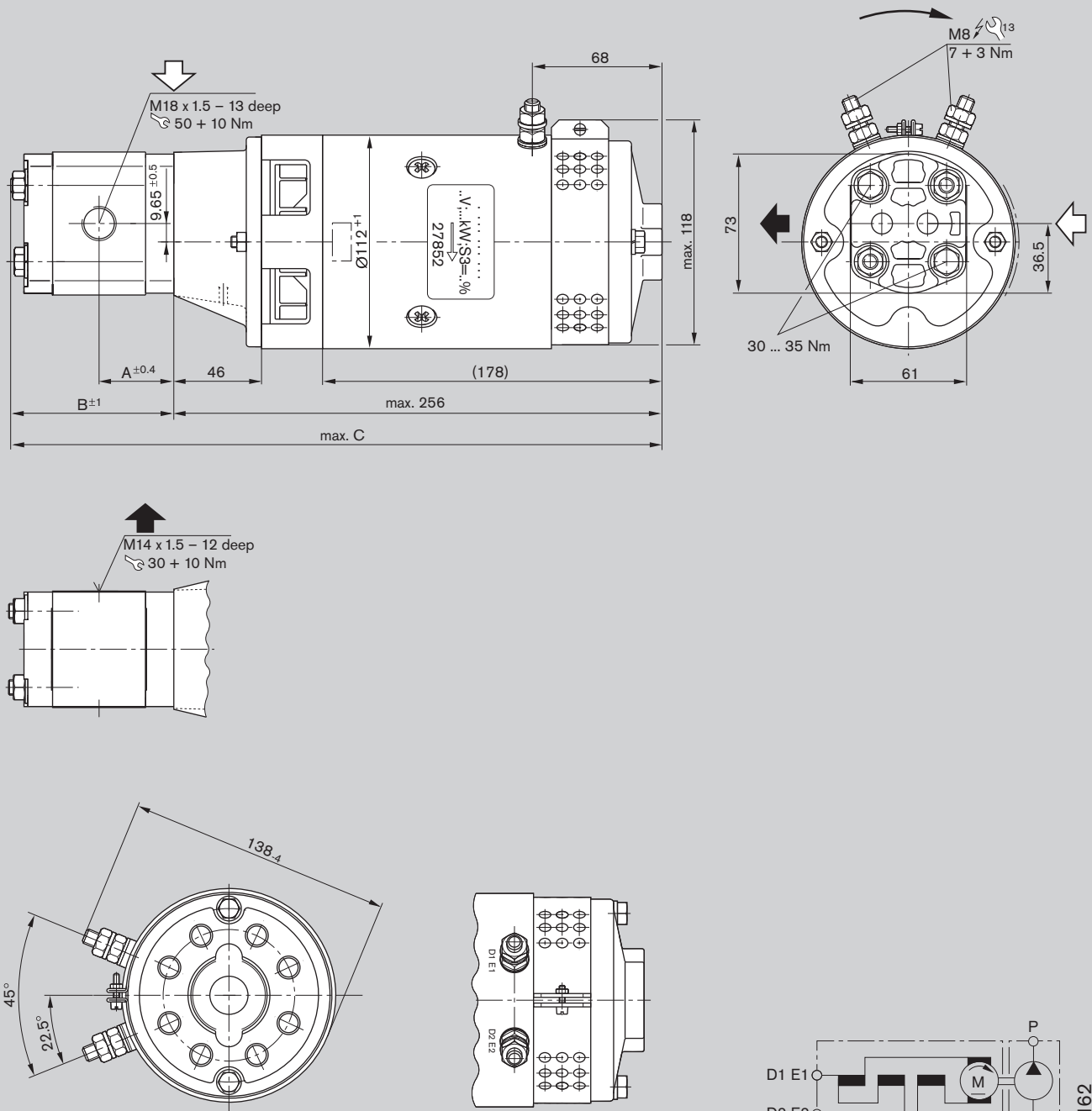

A 541 110 162

Type of protection:  
 Motor case IP 10  
 Ports IP 00

Ordering code	Displacement V [cm <sup>3</sup> /rev]	Dimension [mm]			Weight [kg]	Part number
		A	B	C		
EHP24IDL12B3.0-02A0902N0	3.0	39.0	86.0	343.0	9.9	<b>0 541 100 058</b>

**Characteristics  
for A 541 110 162**

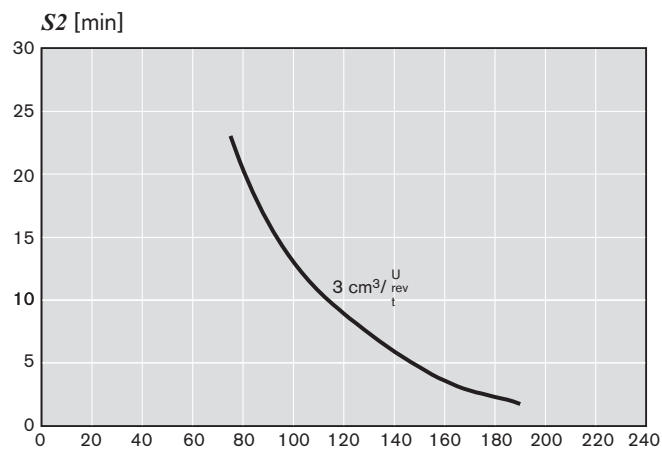
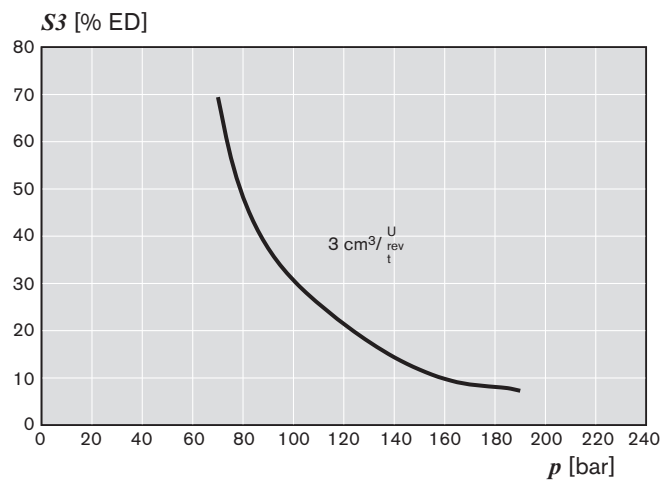
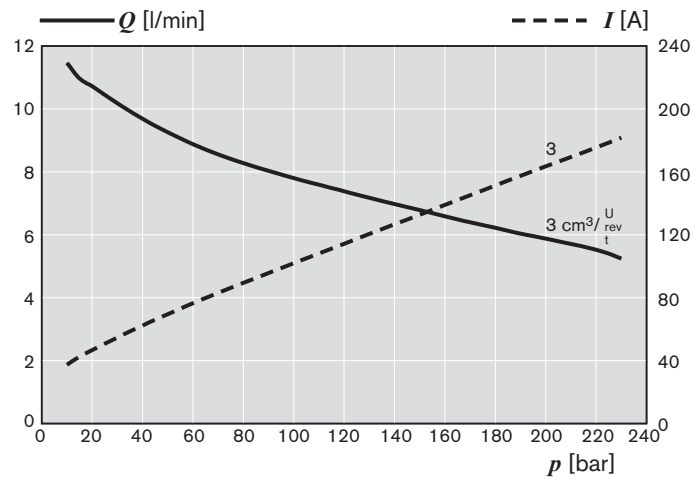

Unit dimensions

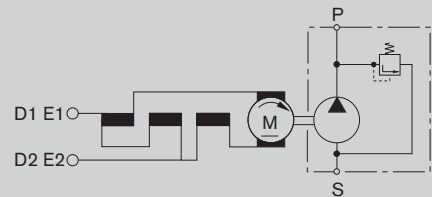
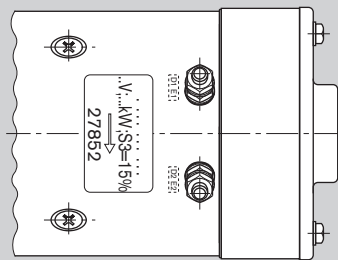
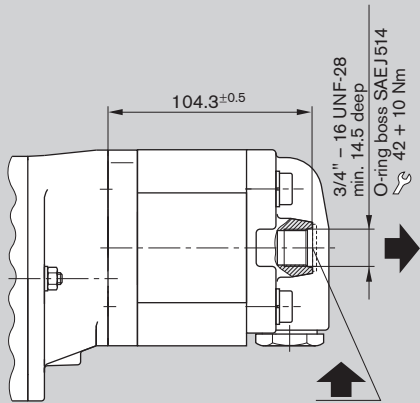
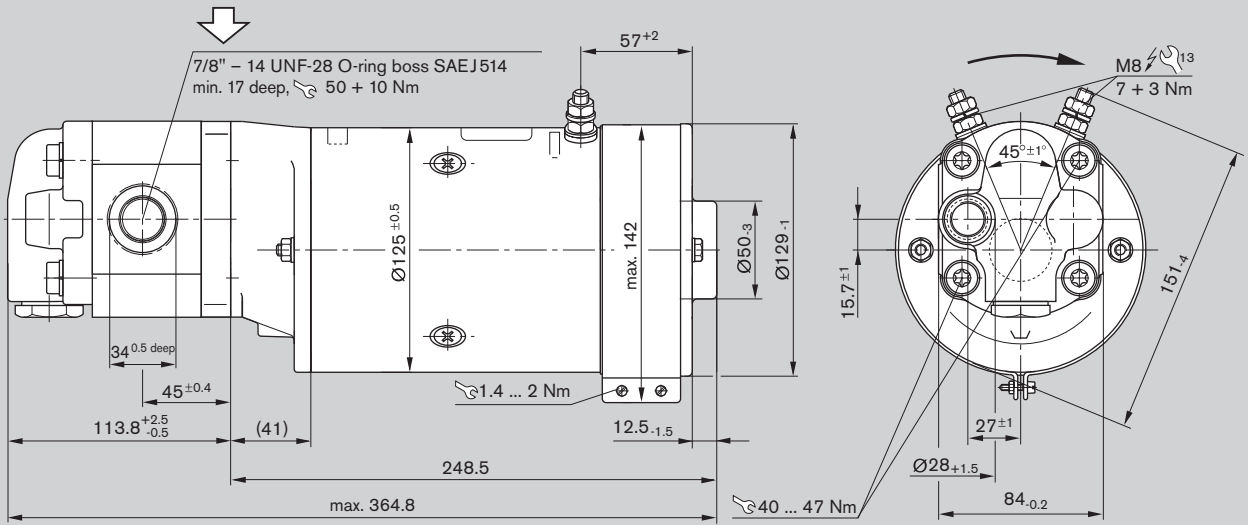

A 541 023 062

Type of protection:

Motor case IP 66

Ports IP 00

Ordering code	Displacement V [cm <sup>3</sup> /rev]	Dimension [mm]			PRV [bar]	Weight [kg]	Part number
		A	B	C			
EHP24KDG66F011-12A0656N0D060	11.0	-	-	-	60 <sup>+5</sup>	16.7	<b>0 541 500 071</b>

**Characteristics  
for A 541 023 062**

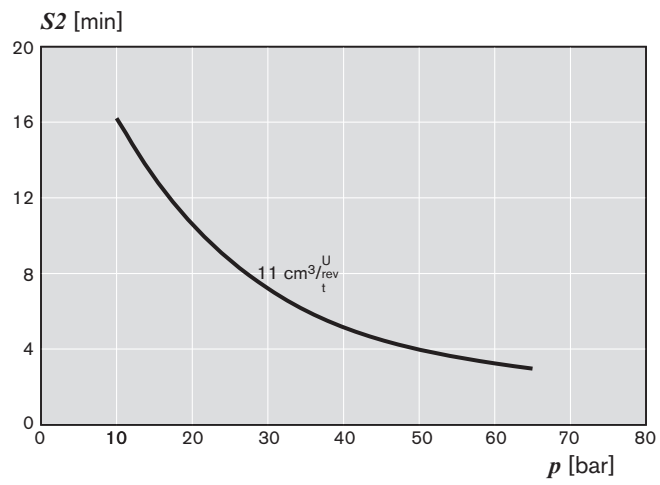
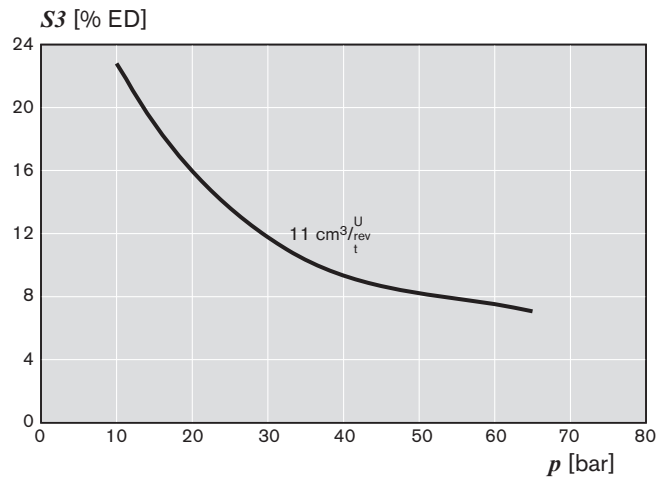
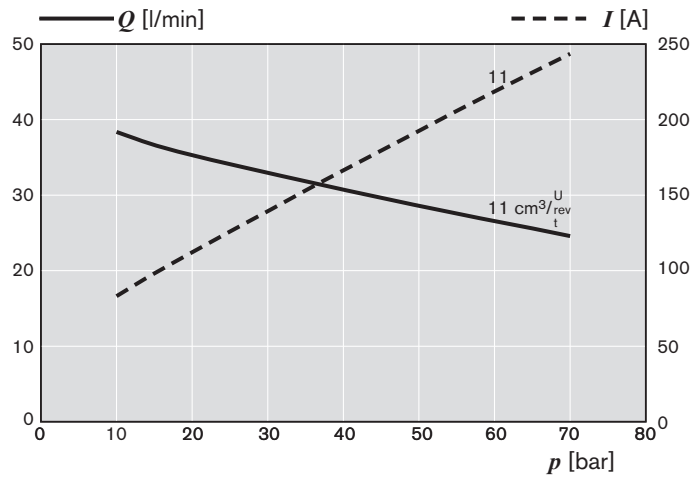

Unit dimensions

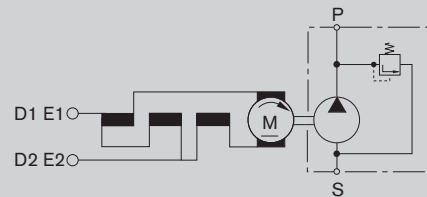
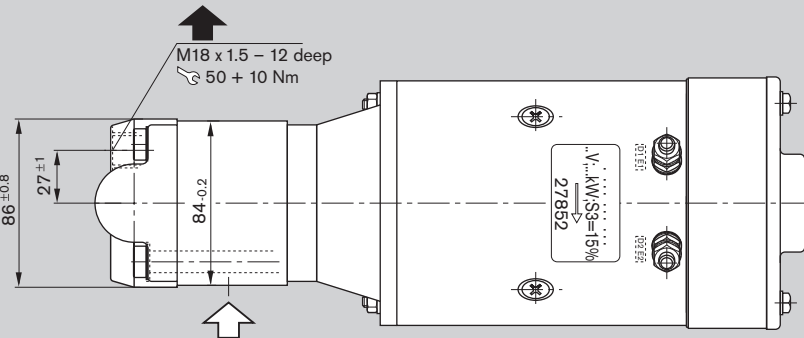
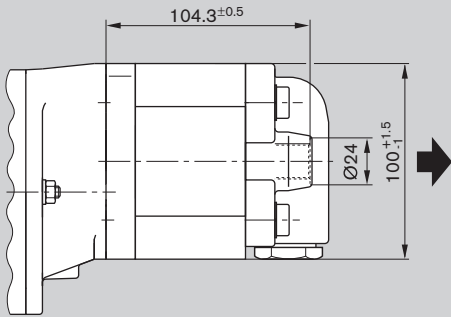
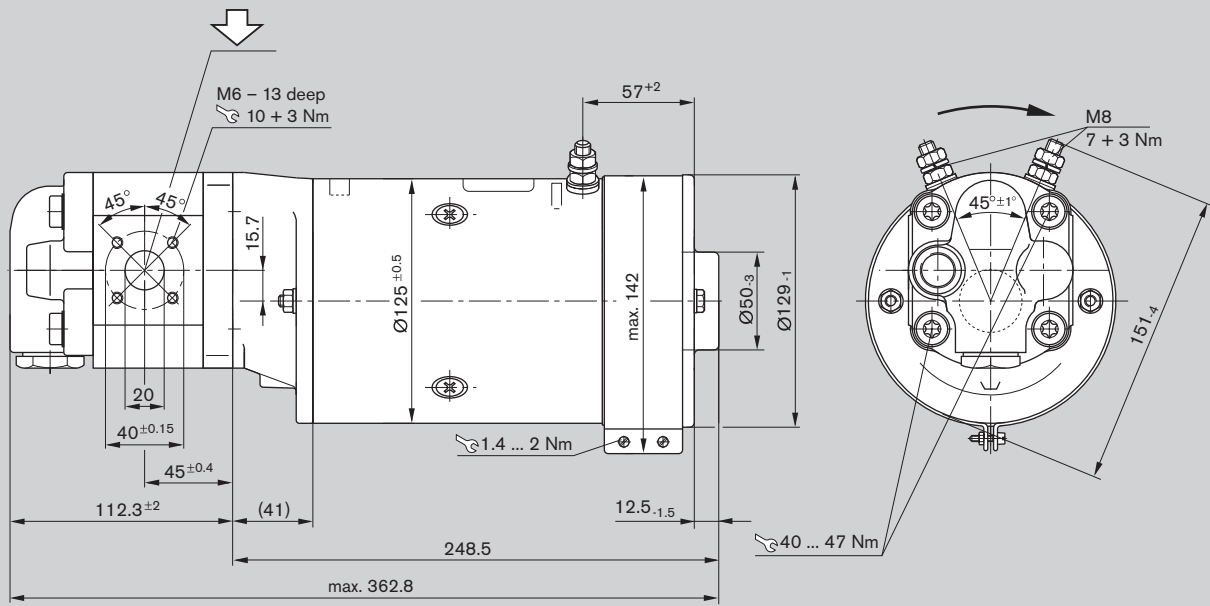

A 541 023 066

Type of protection:

Motor case IP 66

Ports IP 00

Ordering code	Displacement V [cm <sup>3</sup> /rev]	Dimension [mm]			Relay, supplied loose	PRV [bar]	Weight [kg]	Part number
		A	B	C				
EHP24KDG66F011-20A0656L0D050	11.0	-	-	-	1 547 211 007	50 <sup>+5</sup>	16.7	0 541 500 078



**Characteristics  
for A 541 023 066**

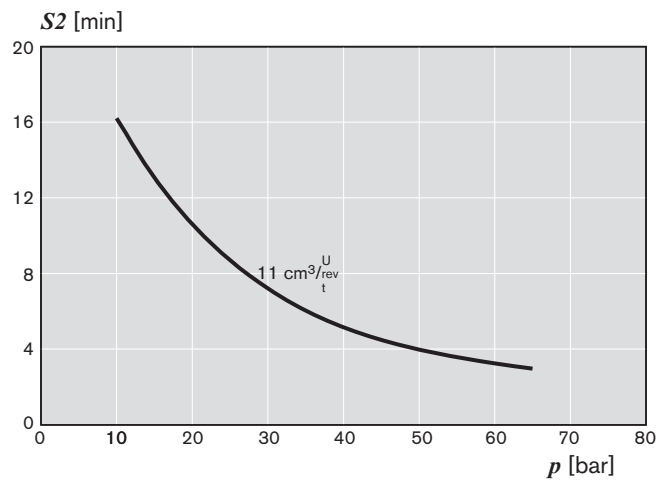
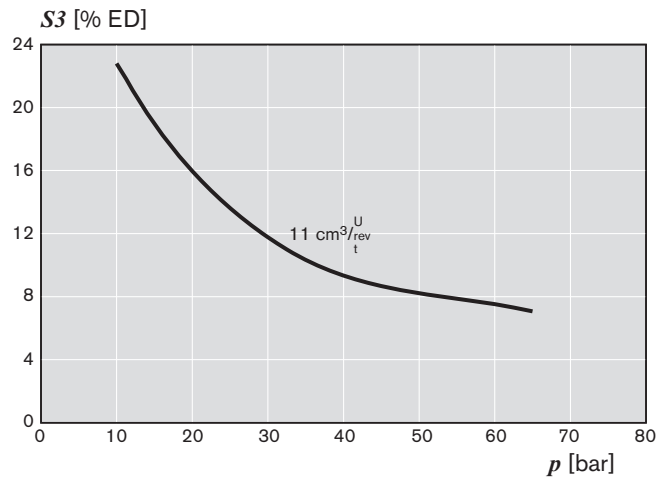
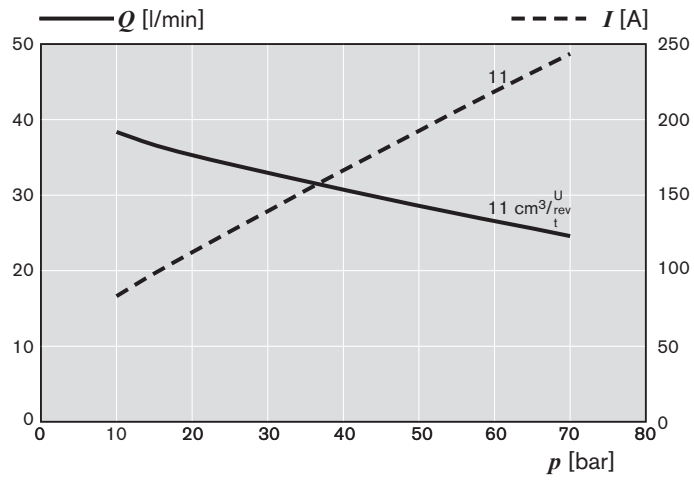

Unit dimensions

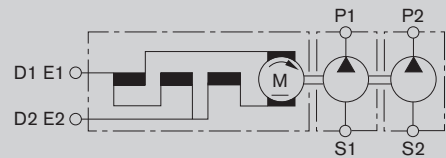
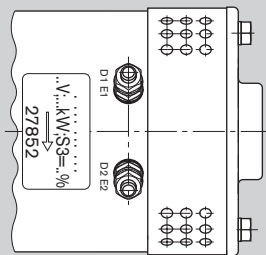
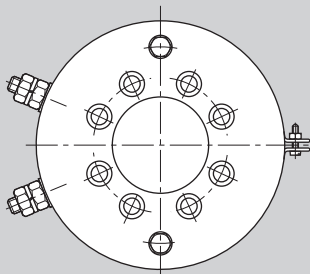
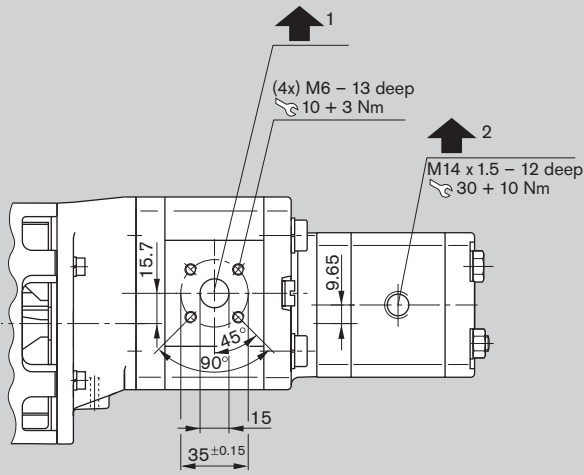
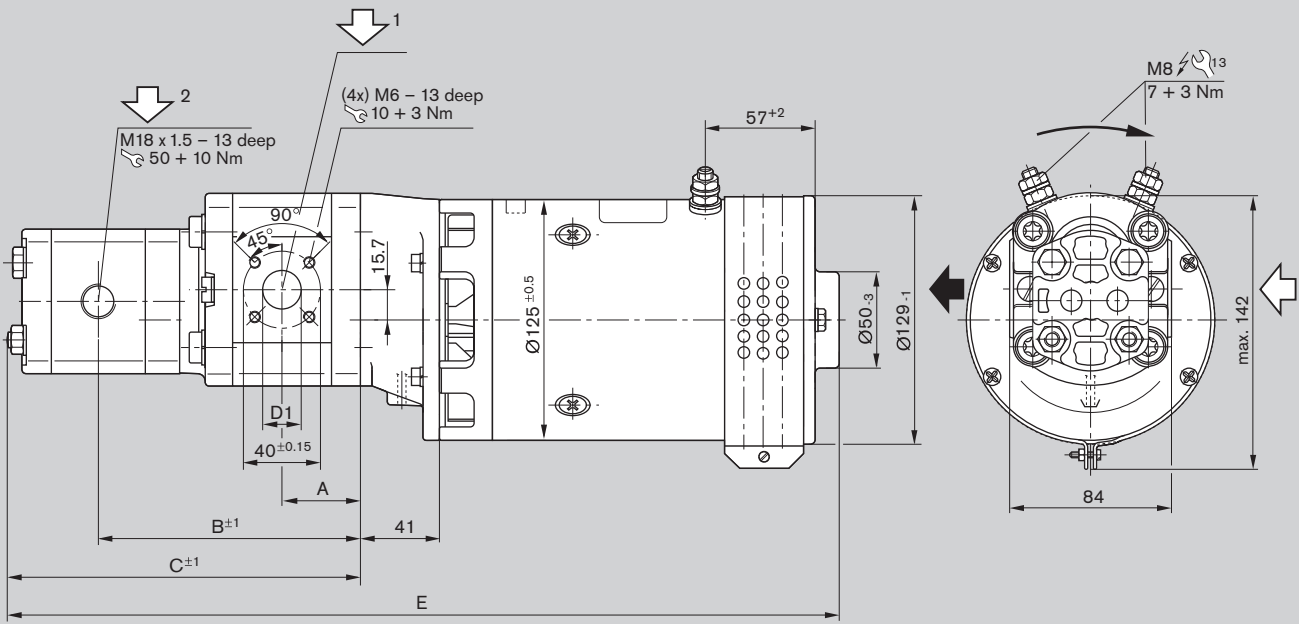

A 541 026 001

Type of protection:

Motor case IP 20

Ports IP 00

Ordering code	Displacement $V$ [cm <sup>3</sup> /rev]	Dimension [mm]					Weight [kg]	Part number
		A	B	C	D	E		
EHP24KDL20FB005/1.0-2002A1096N0	5.5 + 1.0	39.0	124.7	165.7	15.0	443.3	20	<b>0 541 300 058</b>

**Characteristics  
for A 541 001 096**

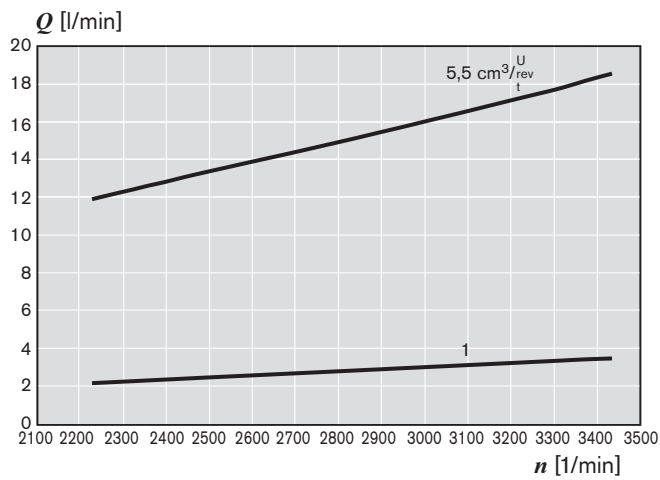
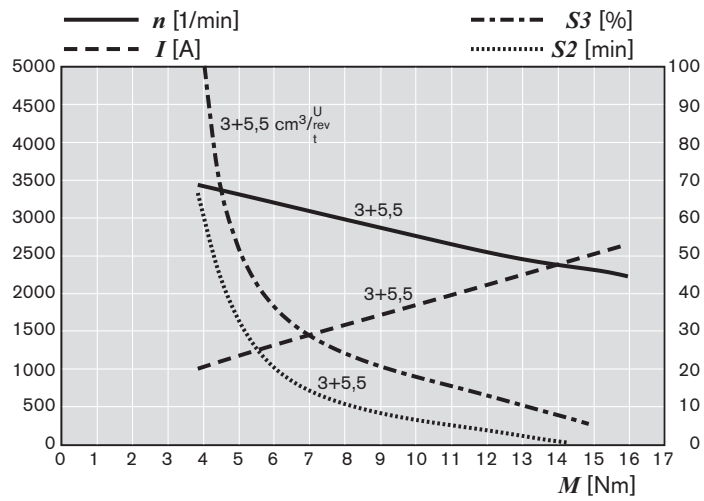
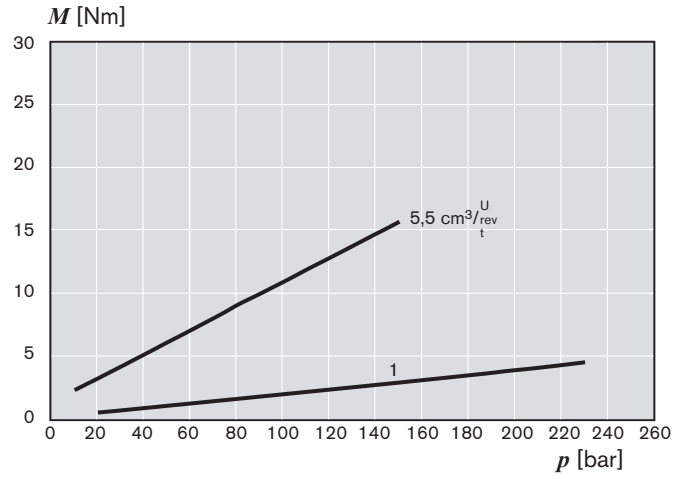

Unit dimensions

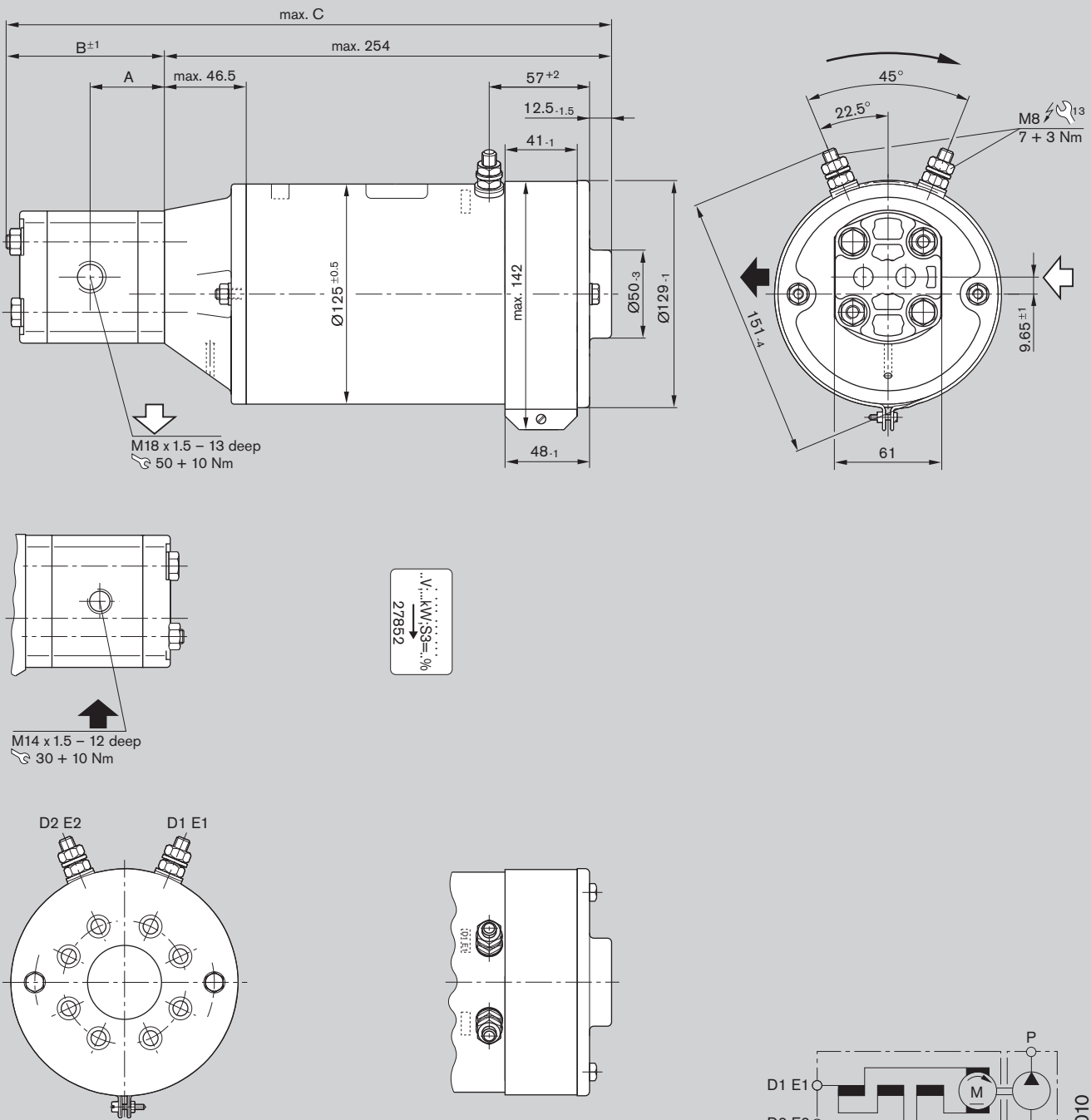

A 541 114 010

Type of protection:

Motor case IP 43

Ports IP 00

Ordering code	Displacement V [cm³/rev]	Dimension [mm]			Weight [kg]	Part number
		A	B	C		
EHP24KDG43B3.0-02A0611N0	3.0	39.2	86.0	341.0	13.5	<b>0 541 100 055</b>

**Characteristics  
for A 541 114 010**

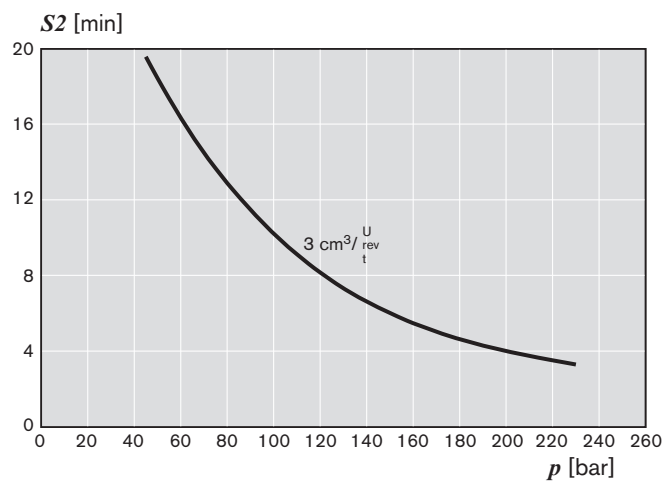
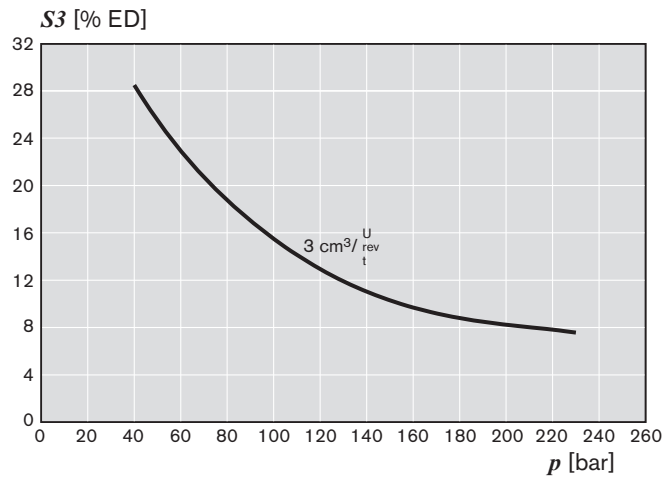
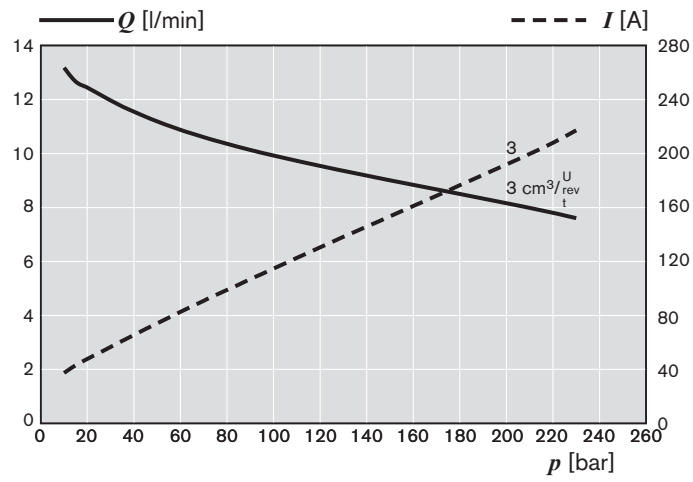

Unit dimensions

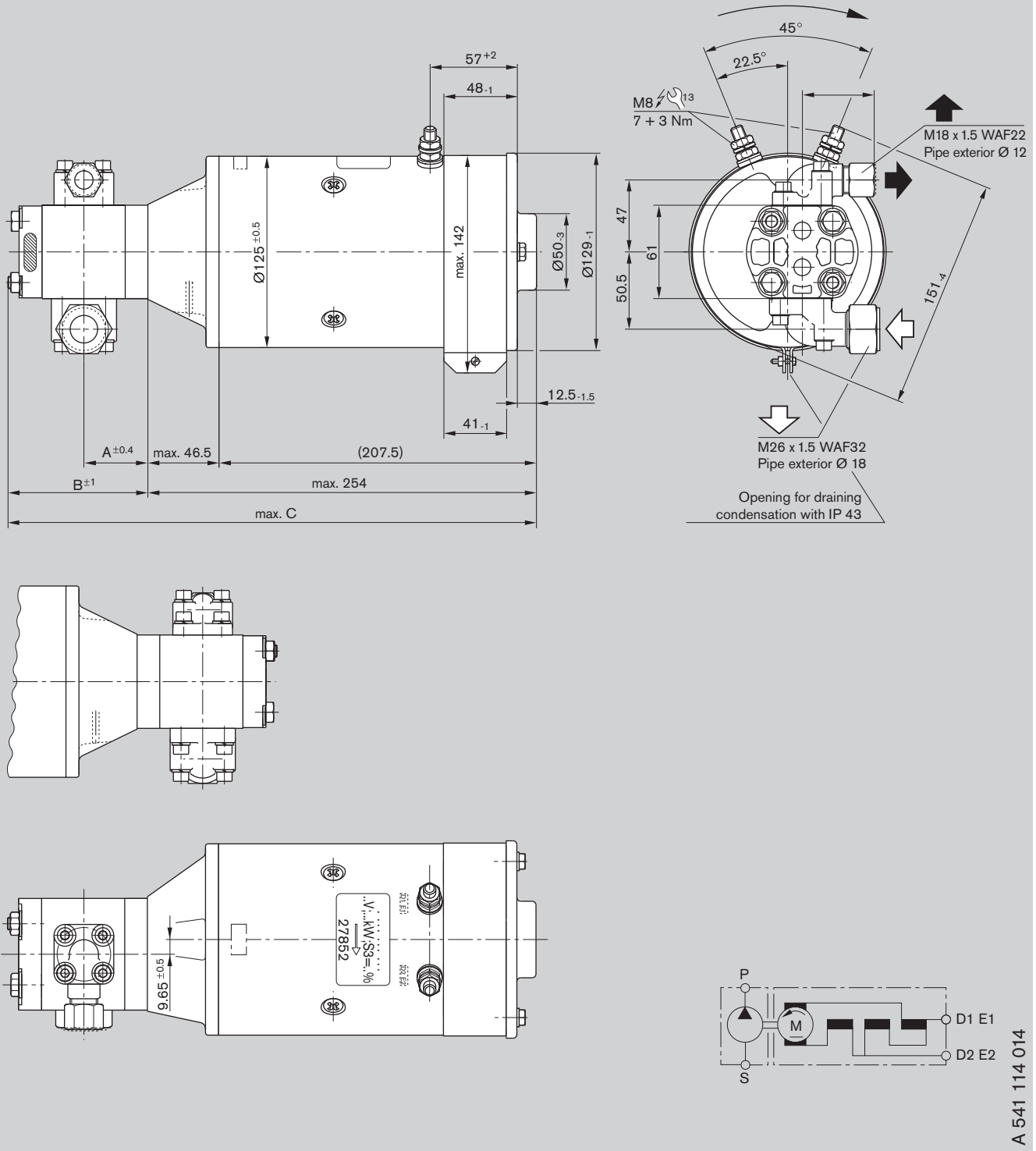

A 541 114 014

Type of protection:  
 Motor case IP 43  
 Ports IP 00

Ordering code	Displacement $V [\text{cm}^3/\text{rev}]$	Dimension [mm]			Weight [kg]	Part number
		A	B	C		
EHP24KDG43B4.6-20C0613N0	4.6	42.0	91.0	346.0	14.1	<b>0 541 200 067</b>

**Characteristics  
for A 541 114 014**

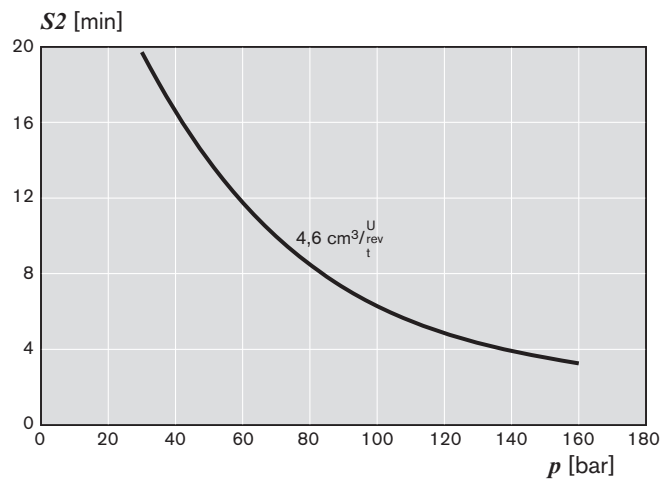
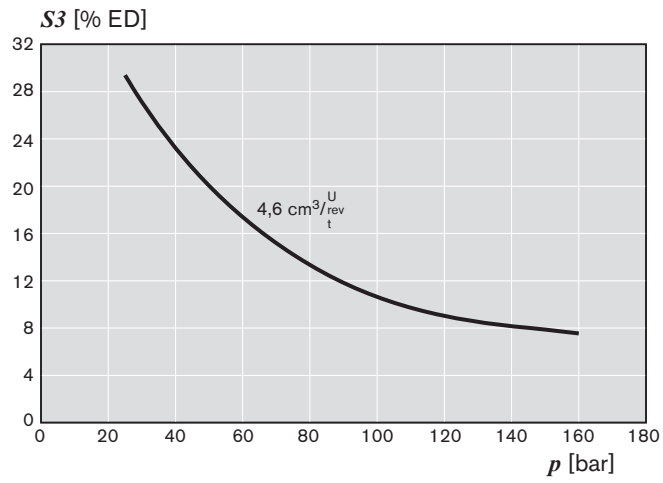
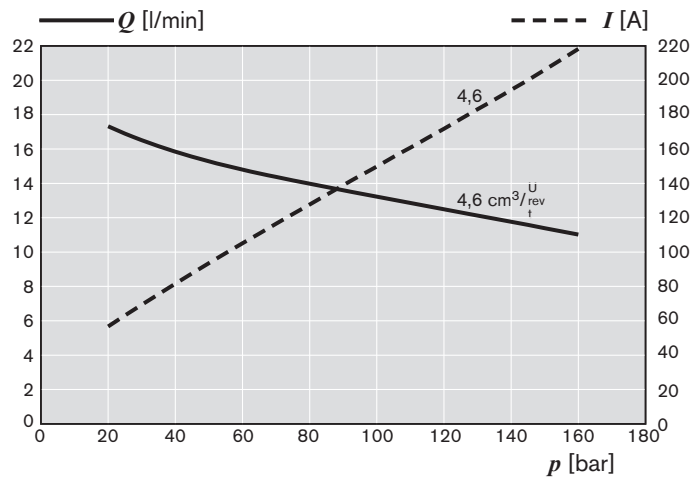

Unit dimensions

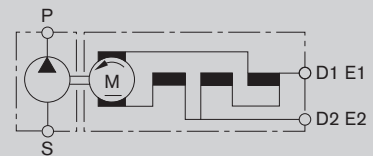
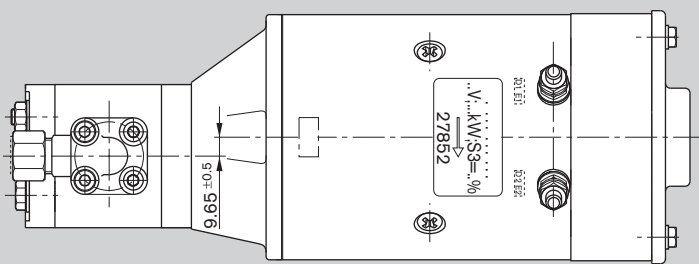
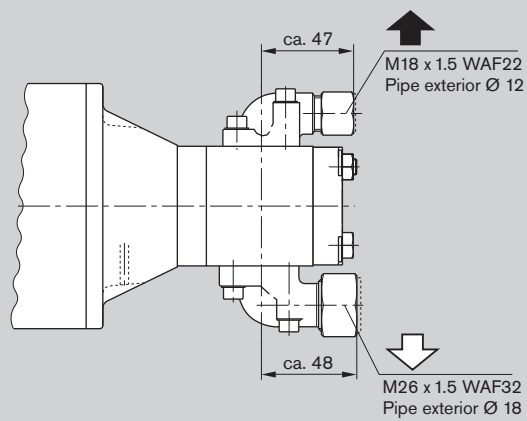
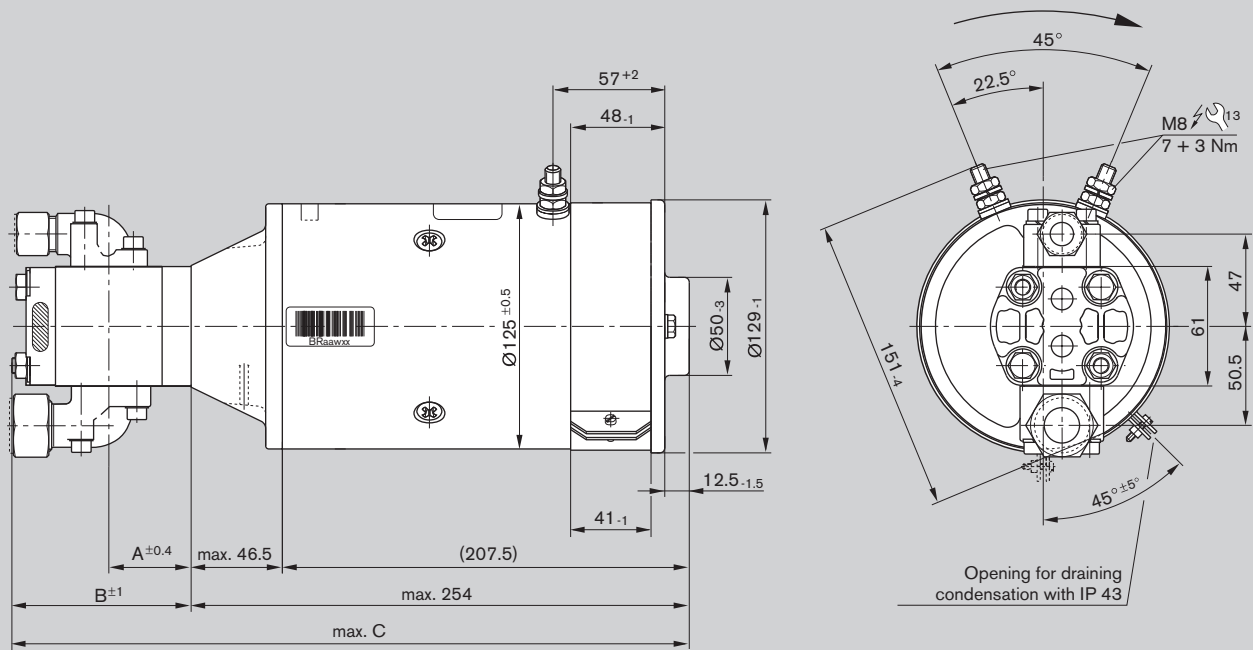

A 541 114 016

Type of protection:

Motor case IP 43  
Ports IP 00

Ordering code	Displacement V [cm <sup>3</sup> /rev]	Dimension [mm]			Weight [kg]	Part number
		A	B	C		
EHP24KDG43B3.8-20C0612N0	3.8	41.0	91.0	346.0	14.3	0 541 100 054



**Characteristics  
for A 541 114 016**

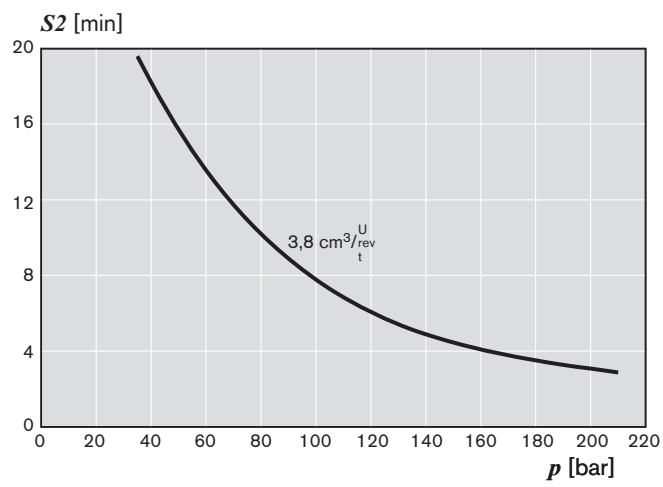
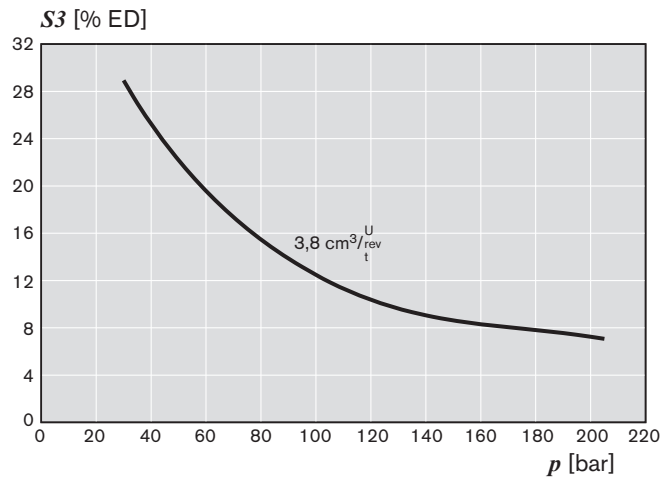
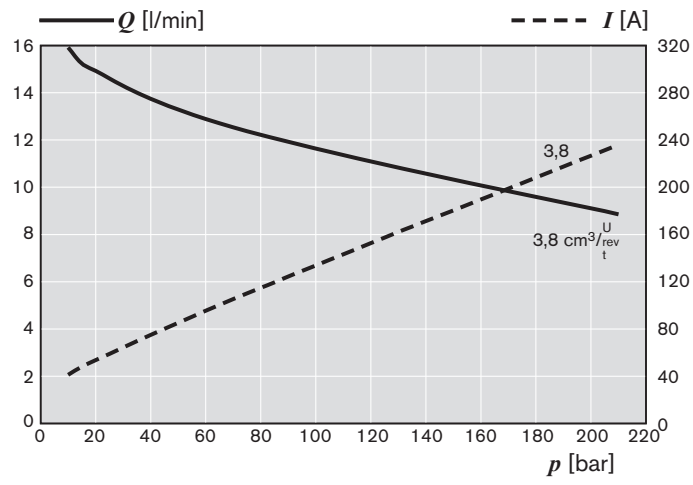

Unit dimensions

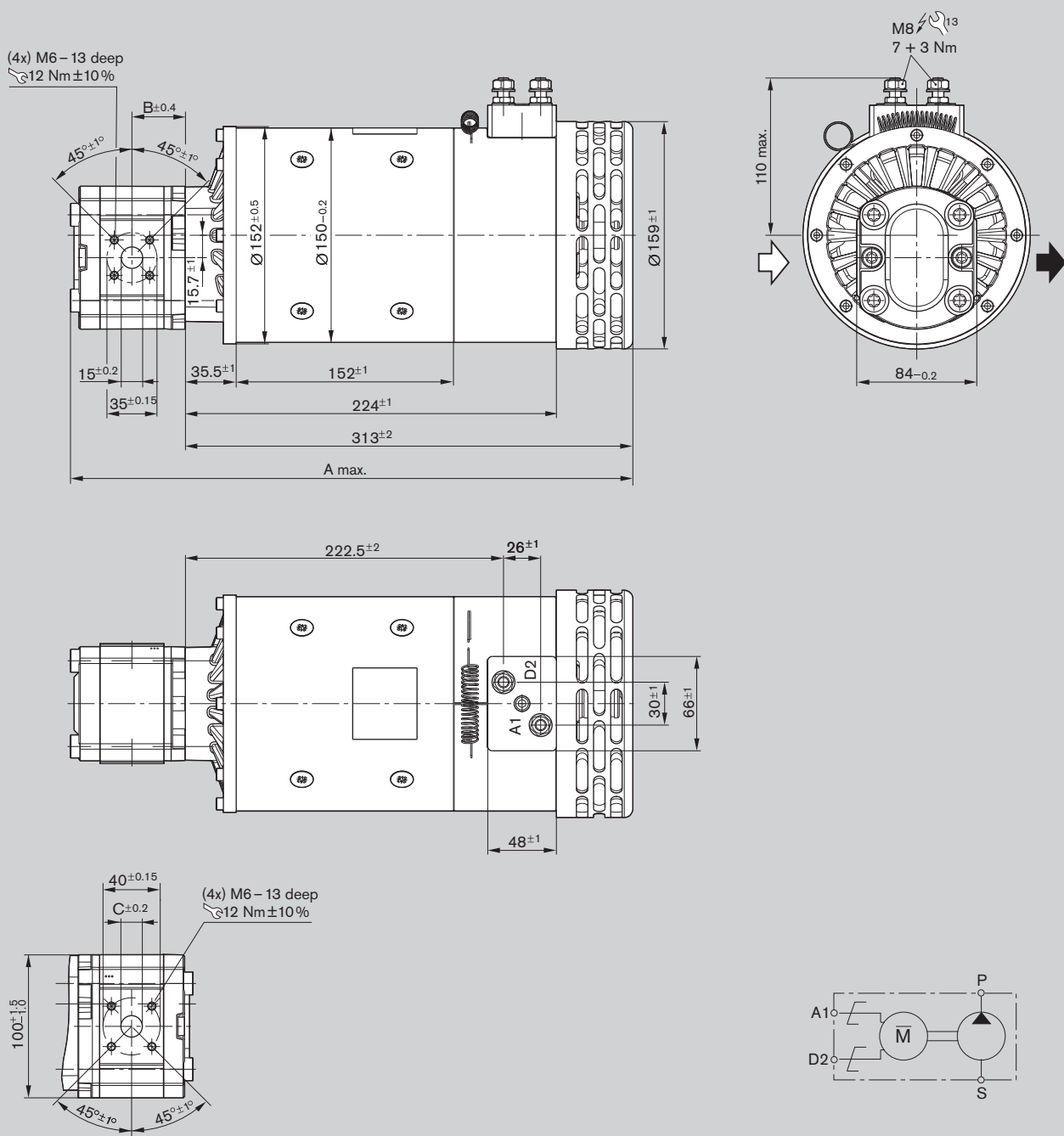

A 541 021 351

Type of protection:

Motor case IP 20  
 Ports IP 00

Ordering code	Displacement V [cm <sup>3</sup> /rev]	Dimension [mm]			Weight [kg]	Part number
		A	B	C		
EHP24PRL20F004-20E1325N0	4.0	396.0	37.4	15.0	20.4	<b>0 541 200 083</b>
EHP24PRL20F005-20E1326N0	5.5	399.0	38.6	15.0	20.4	<b>0 541 300 068</b>
EHP24PRL20F008-20E1327N0	8.0	403.0	40.7	20.0	20.5	<b>0 541 400 075</b>
EHP24PRL20F011-20E1328N0	11.0	408.0	44.5	20.0	20.7	<b>0 541 500 082</b>
EHP24PRL20F016-20E1338N0	16.0	416.0	45.0	20.0	20.9	<b>0 541 600 043</b>

**Characteristics  
for A 541 021 351**

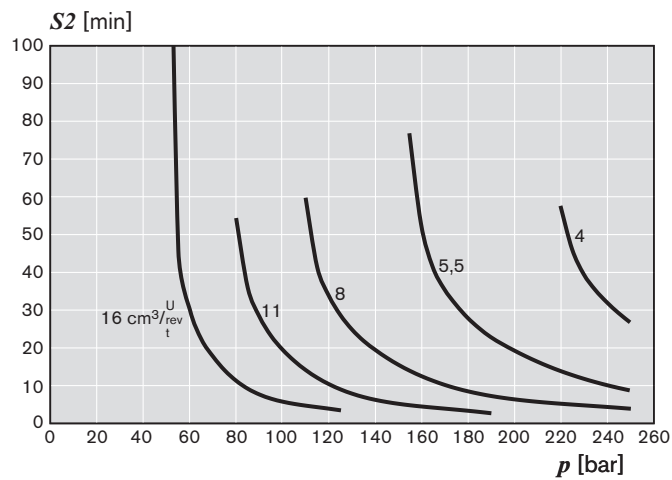
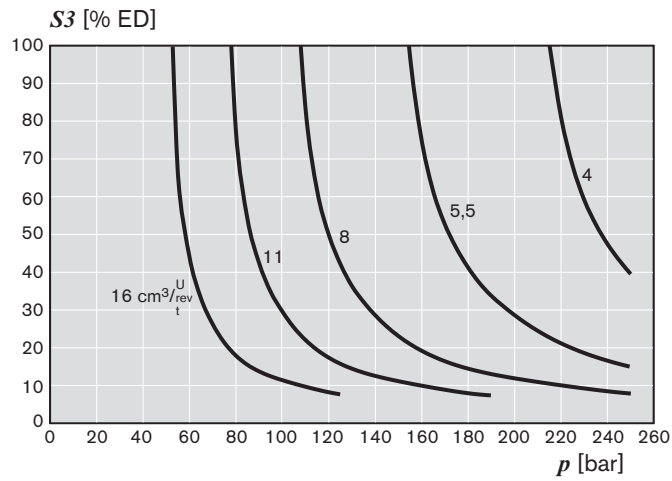
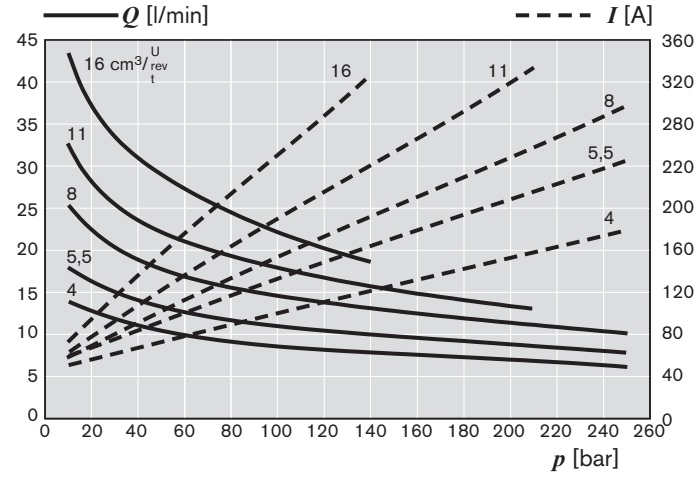

Unit dimensions

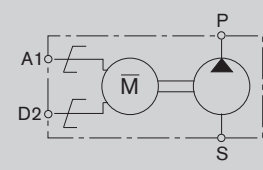
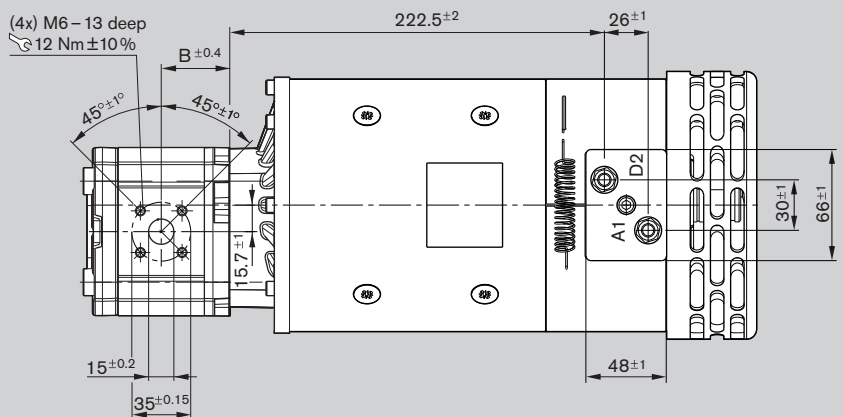
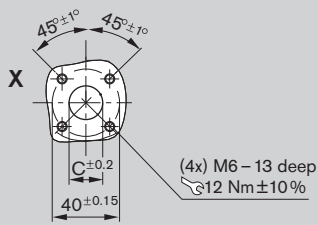
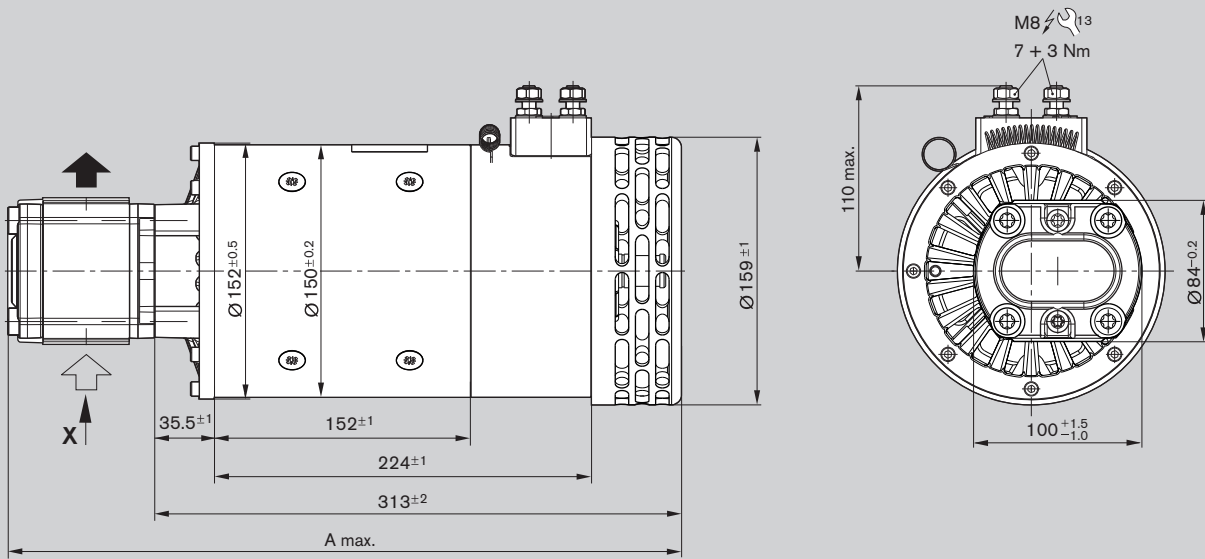

A 541 021 367

Type of protection:  
 Motor case IP 20  
 Ports IP 00

Ordering code	Displacement V [cm <sup>3</sup> /rev]	Dimension [mm]			kg	Part number
		A	B	C		
EHP24PRL20F008-20C1327N0	8.0	403	40.7	20	20.5	<b>0 541 400 079</b>

**Characteristics  
for A 541 021 367**

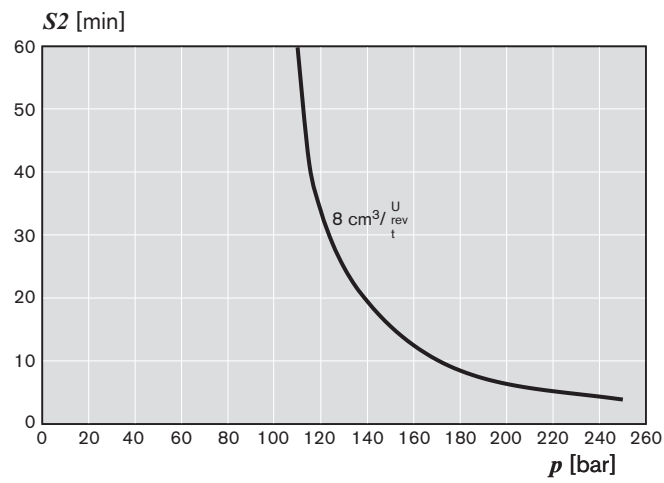
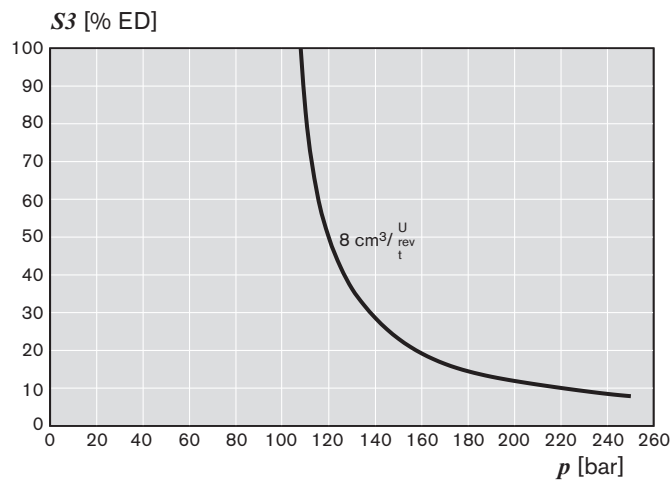
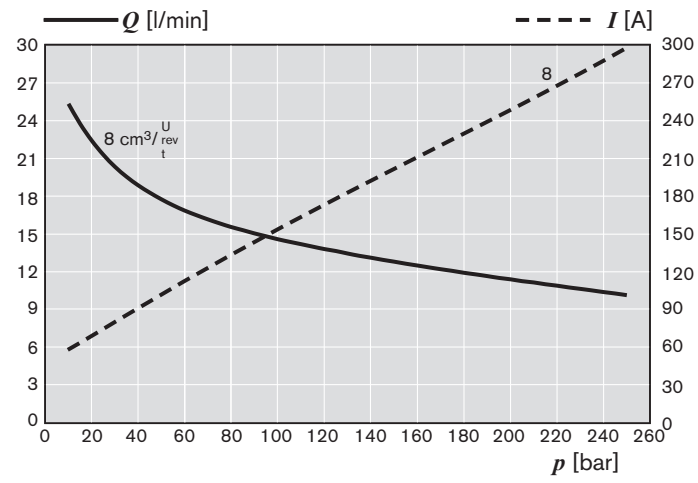

Unit dimensions

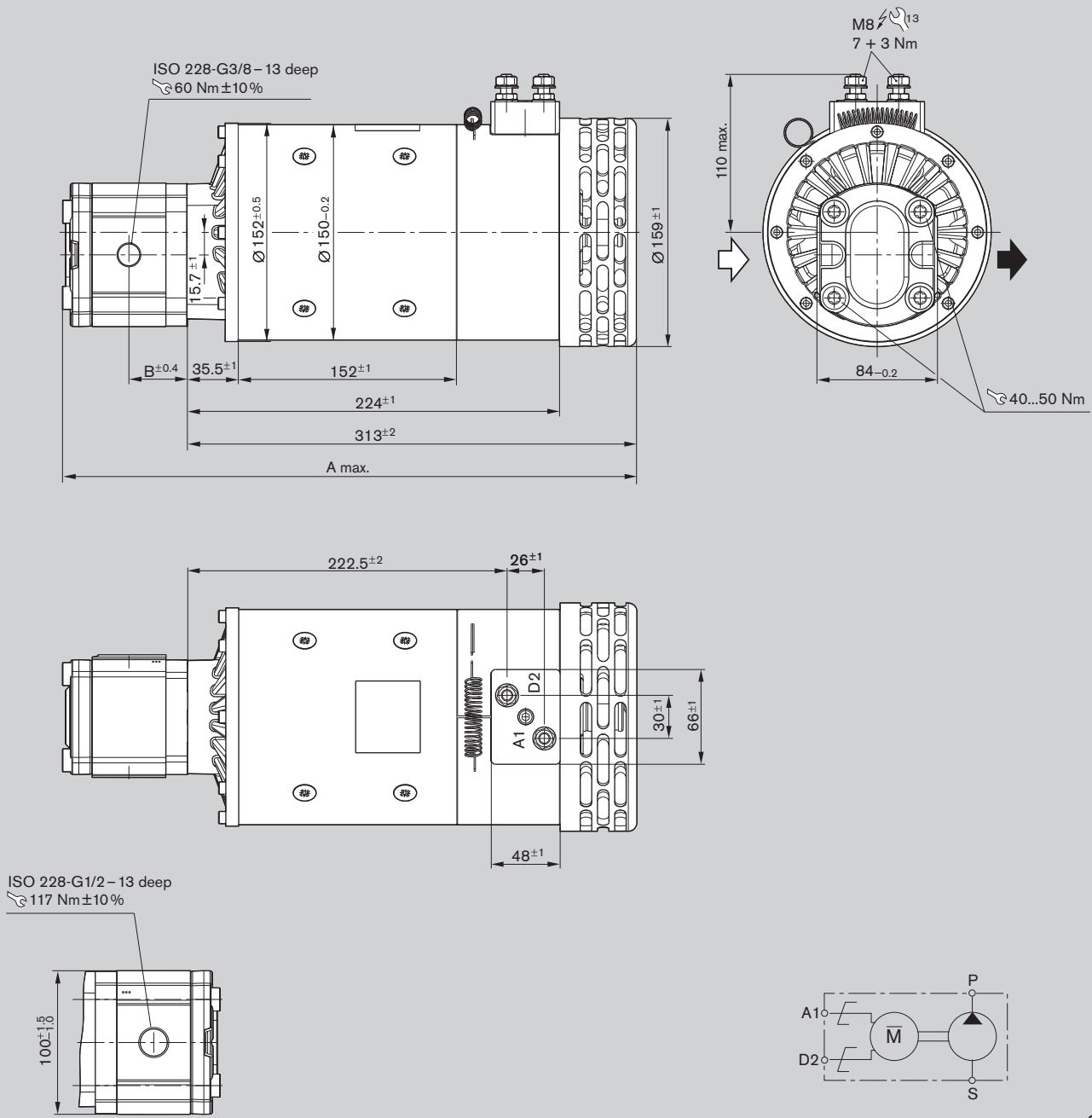

A 541 021 383

Type of protection:

Motor case IP 20  
 Ports IP 00

Ordering code	Displacement $V [\text{cm}^3/\text{rev}]$	Dimension [mm]		Weight [kg]	Part number
		A	B		
EHP24PRL20F008-01E1327N0	8.0	403	40.7	20.5	<b>0 541 400 083</b>

**Characteristics  
for A 541 021 383**

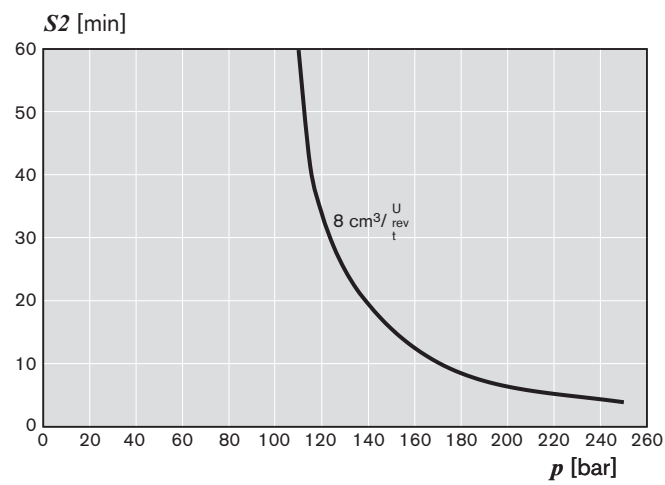
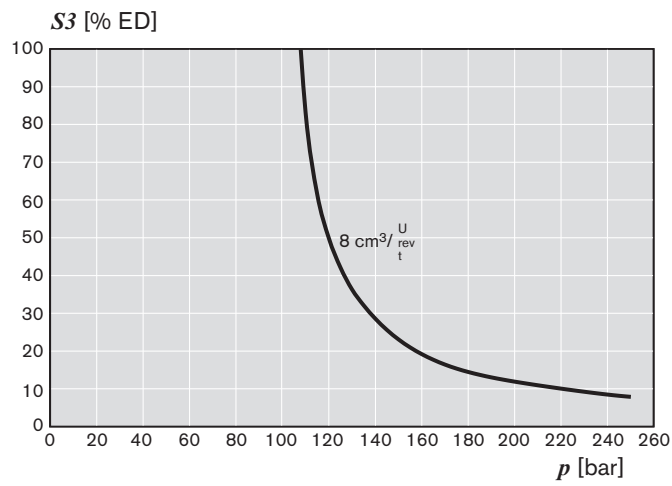
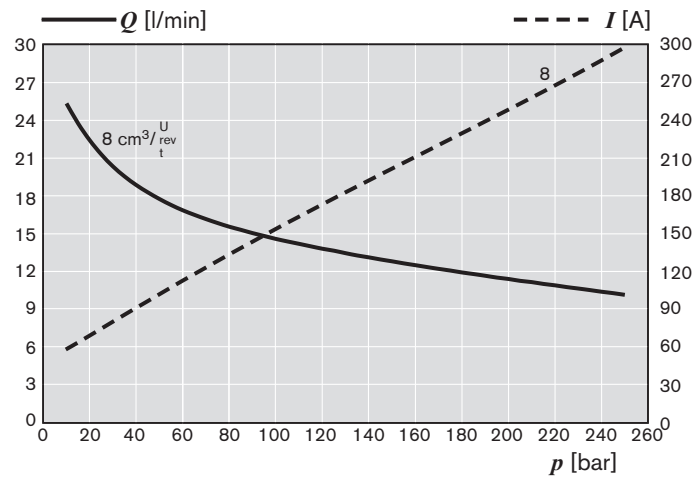

Unit dimensions

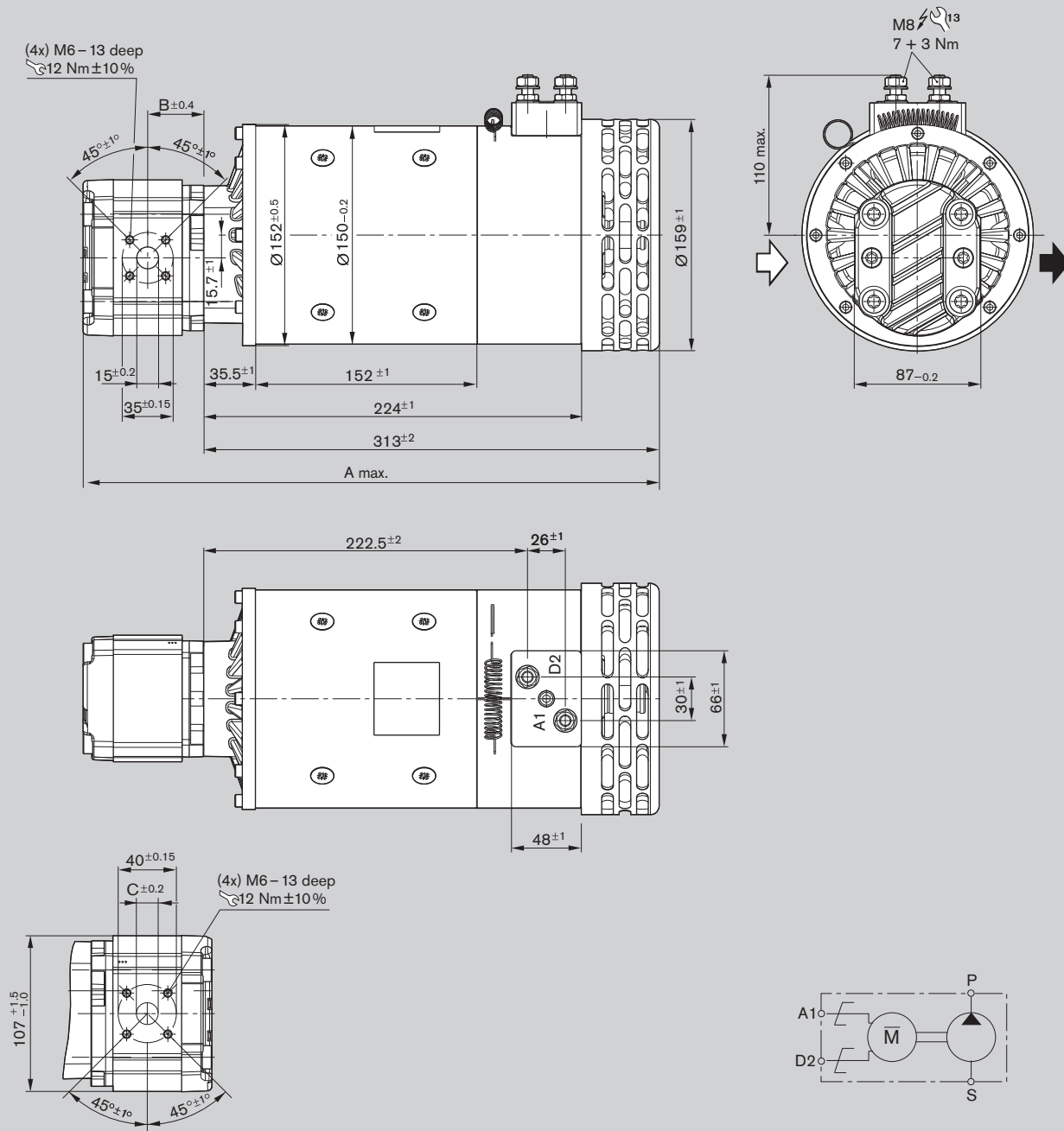

A 541 021 358

Type of protection:

Motor case IP 20

Ports IP 00

Ordering code	Displacement $V$ [cm <sup>3</sup> /rev]	Dimension [mm]			Weight [kg]	Part number
		A	B	C		
EHP24PRL24S008-20E1335N0	8.0	403	40.7	20	20.6	<b>0 541 400 077</b>
EHP24PRL24S011-20E1337N0	11.0	408	44.5	20	20.7	<b>0 541 500 083</b>



**Characteristics  
for A 541 021 358**

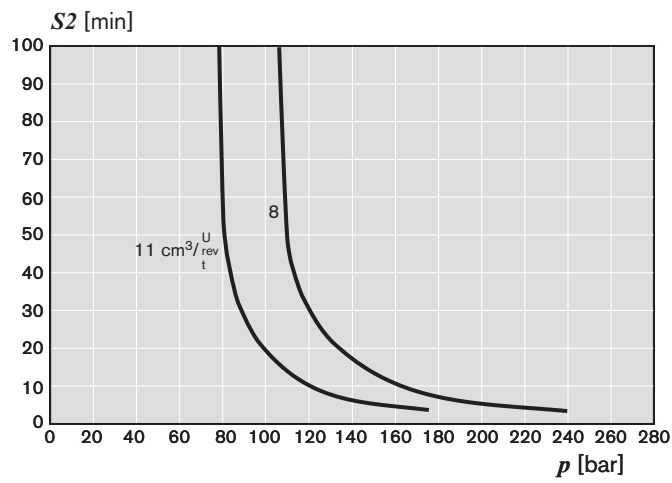
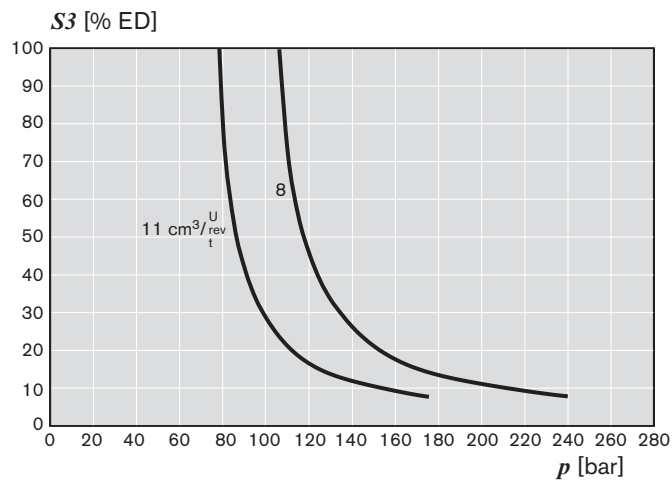
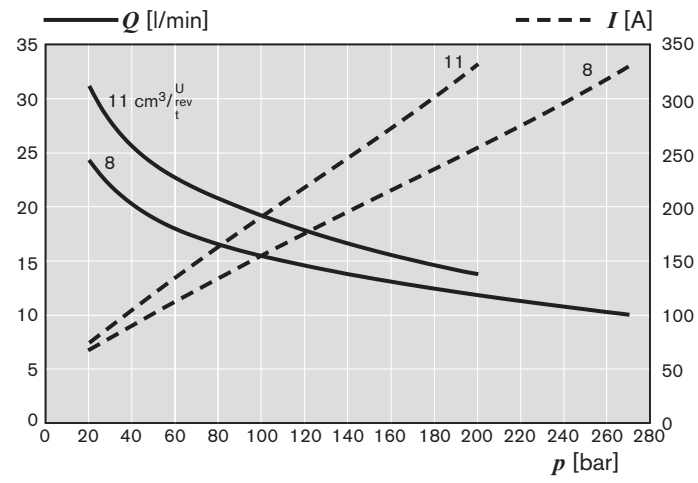

Unit dimensions

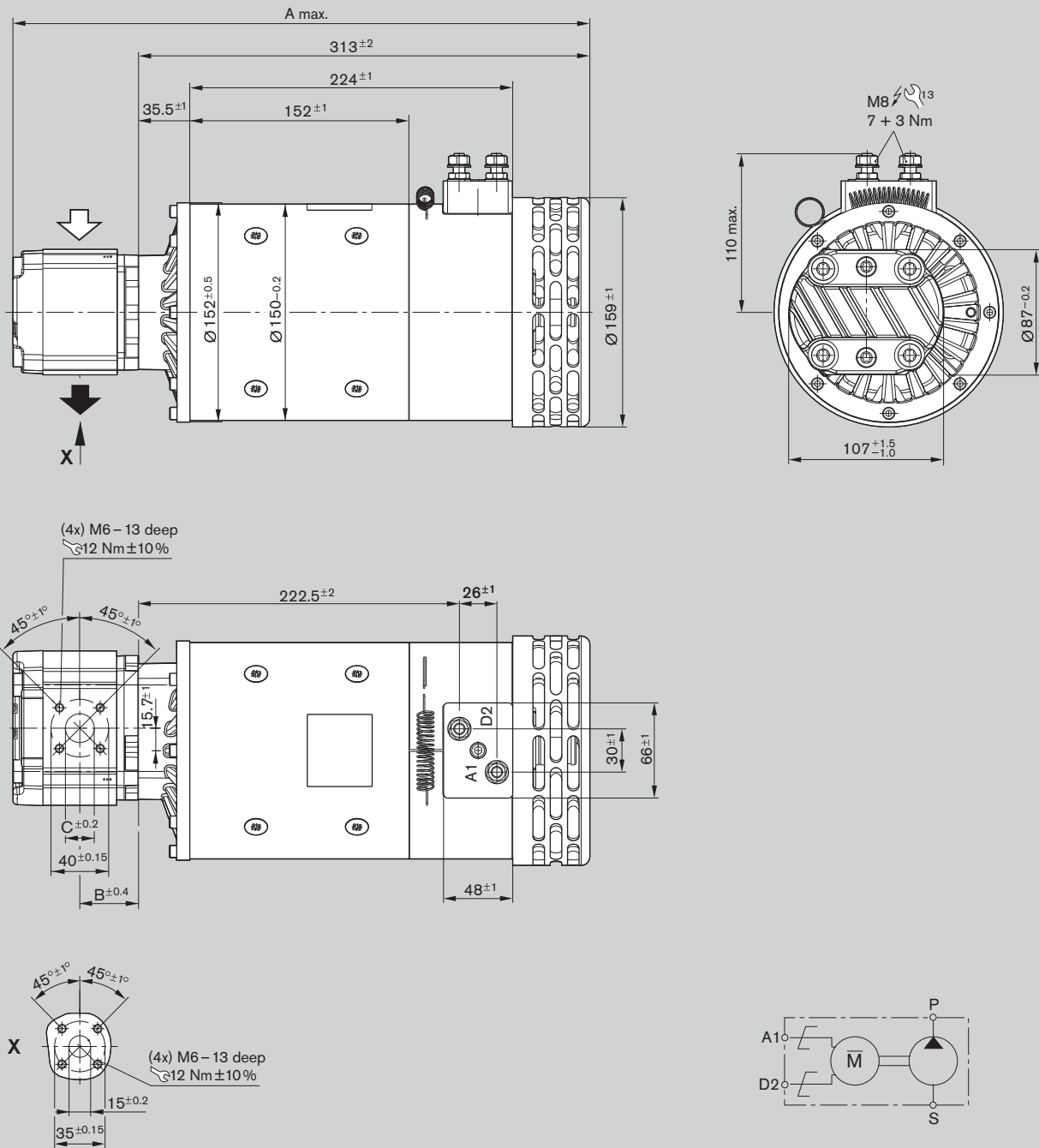

A 541 021 382

Type of protection:

Motor case IP 20

Ports IP 00

Ordering code	Displacement $V$ [cm <sup>3</sup> /rev]	Dimension [mm]			Weight [kg]	Part number
		A	B	C		
EHP24PRL20S008-20G1335N0	8.0	403	40.7	20	20.6	<b>0 541 400 082</b>

**Characteristics  
for A 541 021 382**

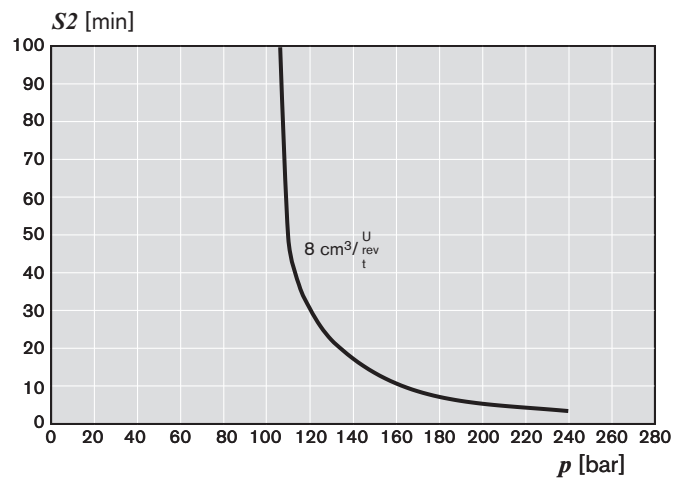
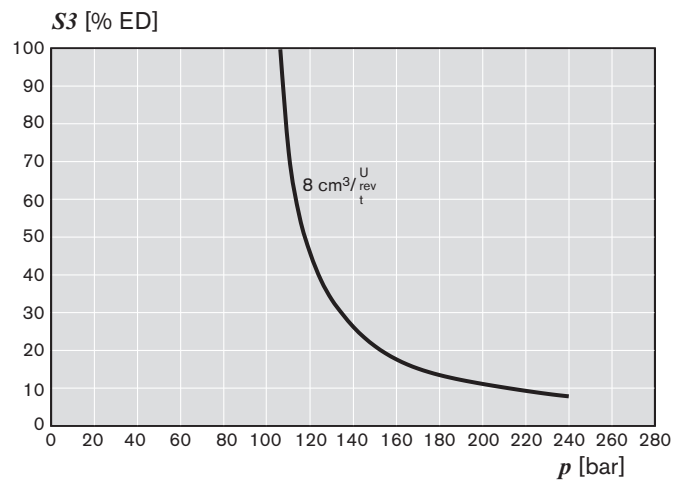
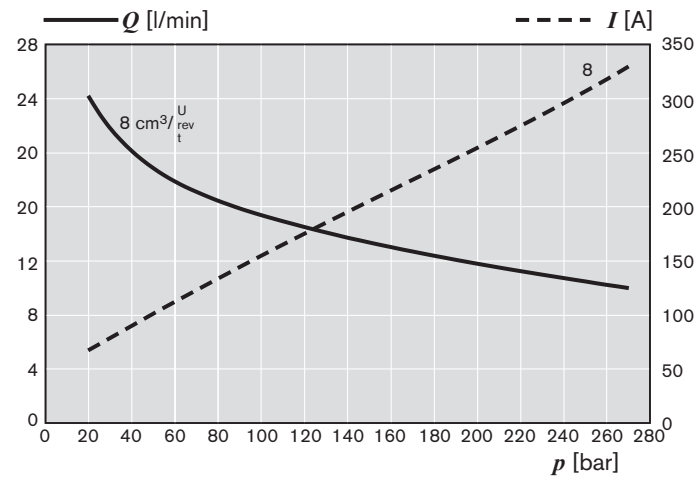

Unit dimensions

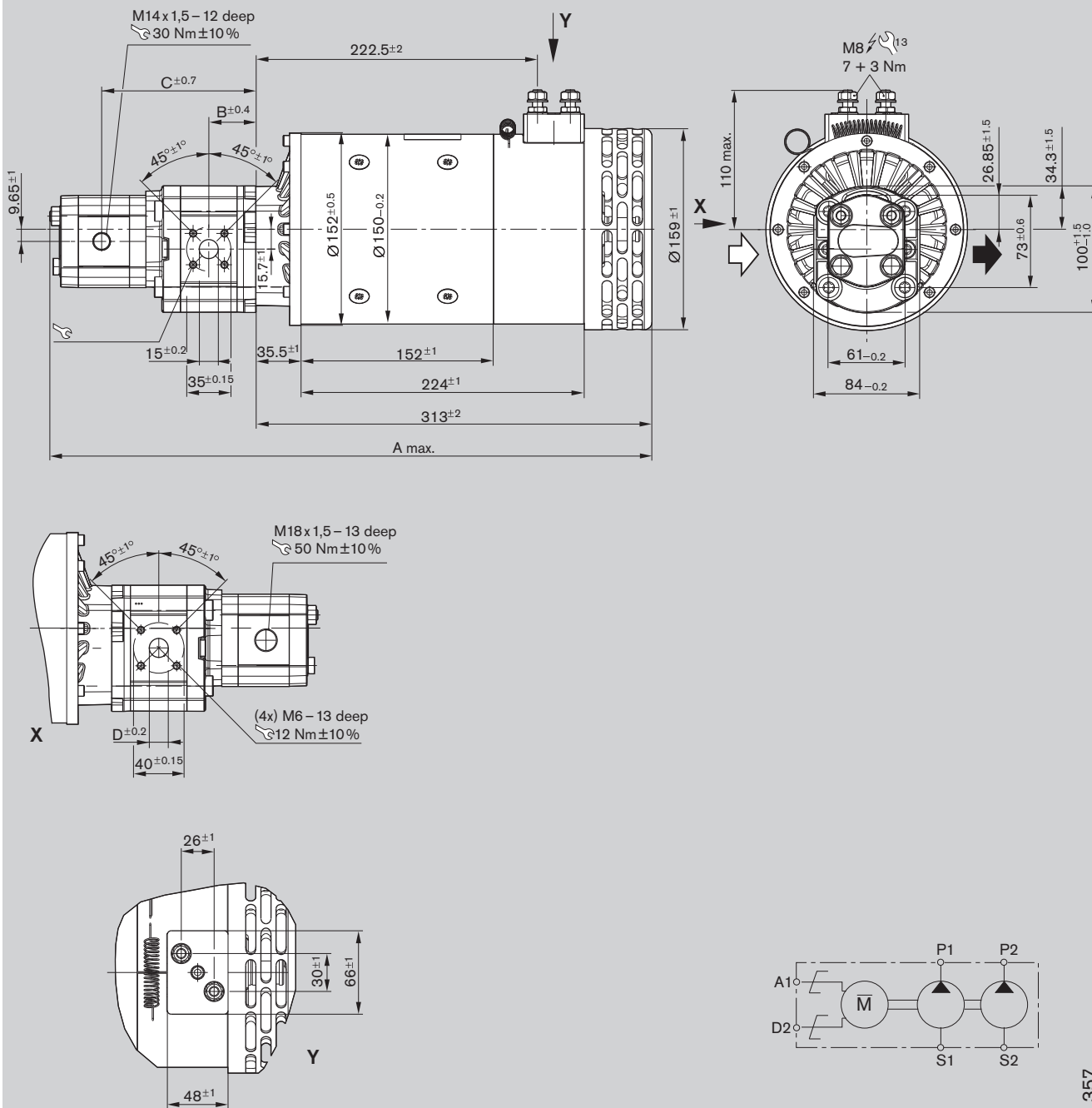

A 541 021 357

Type of protection:

Motor case IP 20

Ports IP 00

Ordering code	Förder- volumen V [cm <sup>3</sup> /rev]	Dimension [mm]				Weight [kg]	Part number
		A	B	C	D		
EHP24PRL20FB005/3.0-2002E1324N0	5.5 + 3.0	492	38.6	128.9	15	21.6	<b>0 541 300 069</b>

**Characteristics  
for A 541 021 357**

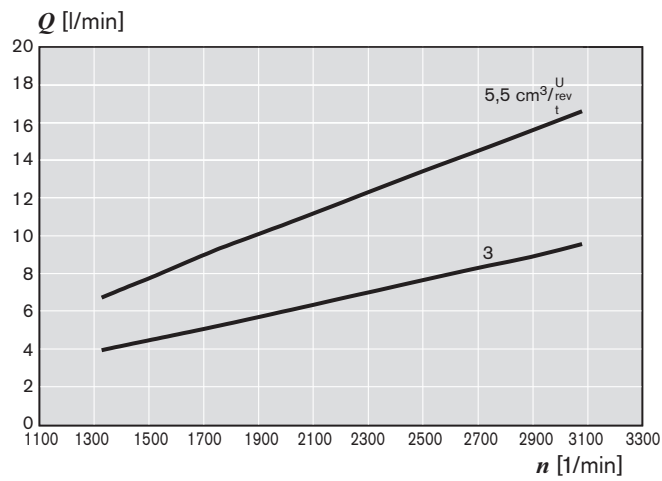
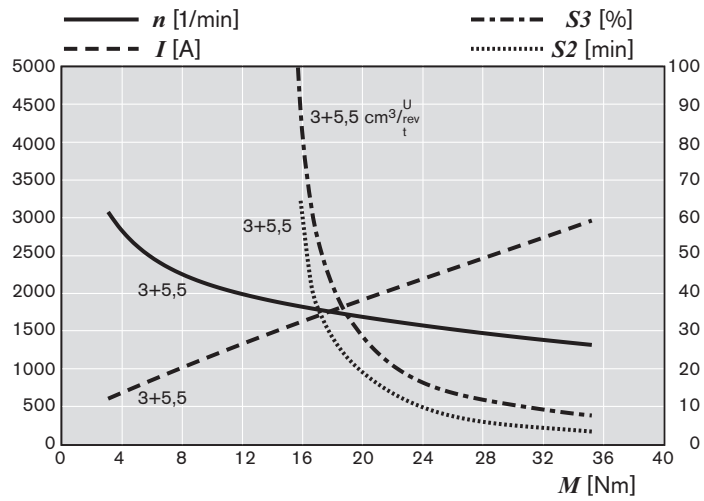
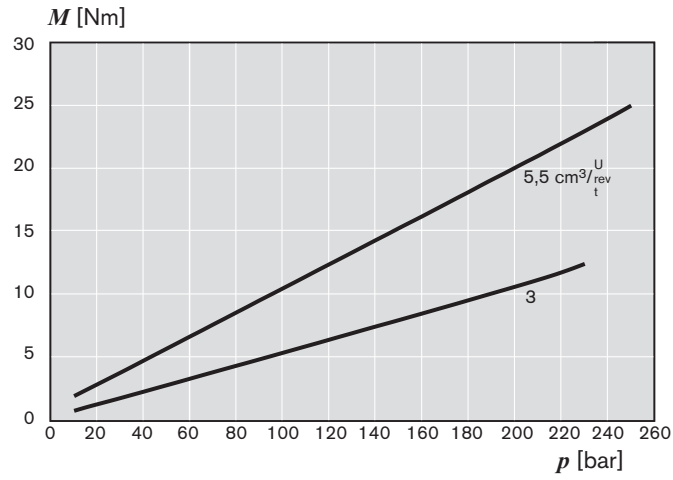

Unit dimensions

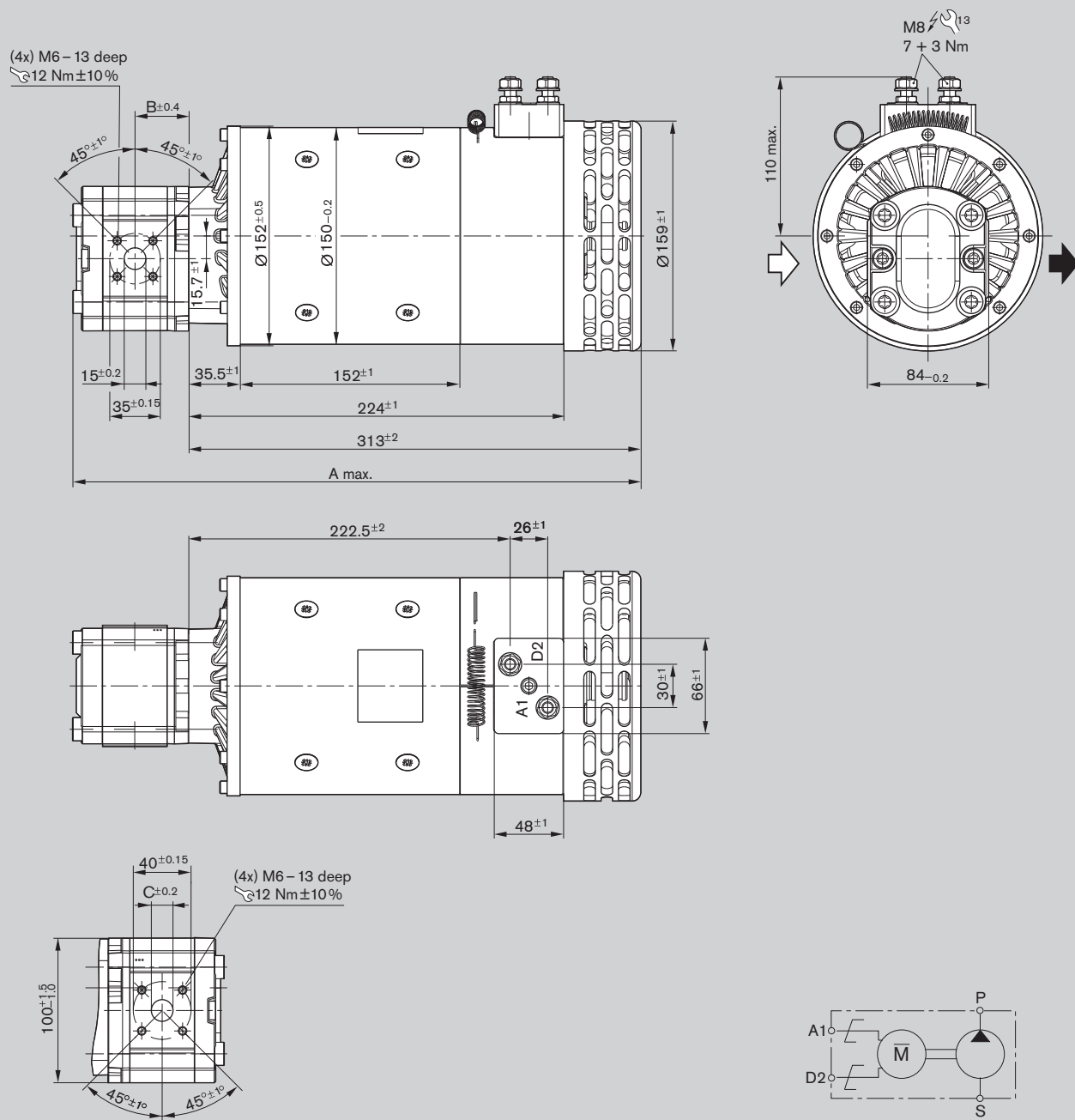

A 541 021 368

Type of protection:

Motor case IP 20

Ports IP 00

Ordering code	Displacement V [cm <sup>3</sup> /rev]	Dimension [mm]			Weight [kg]	Part number
		A	B	C		
EHP48PRL20F005-20E1341N0	5.5	399	38.6	15	20.4	0 541 300 074
EHP48PRL20F008-20E1344N0	8.0	403	40.7	20	20.5	0 541 400 080

**Characteristics  
for A 541 021 368**

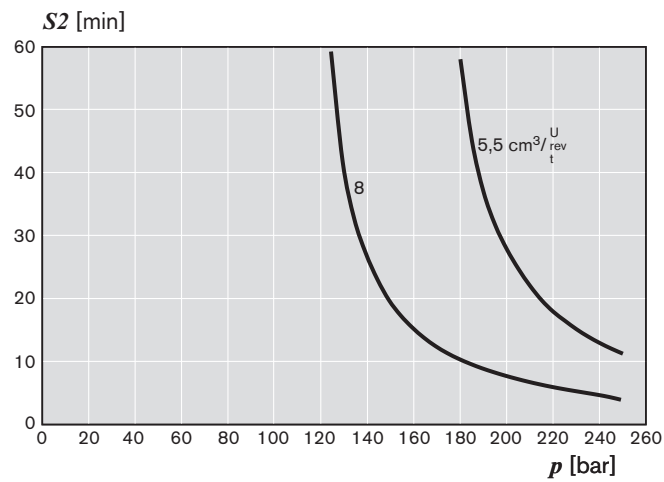
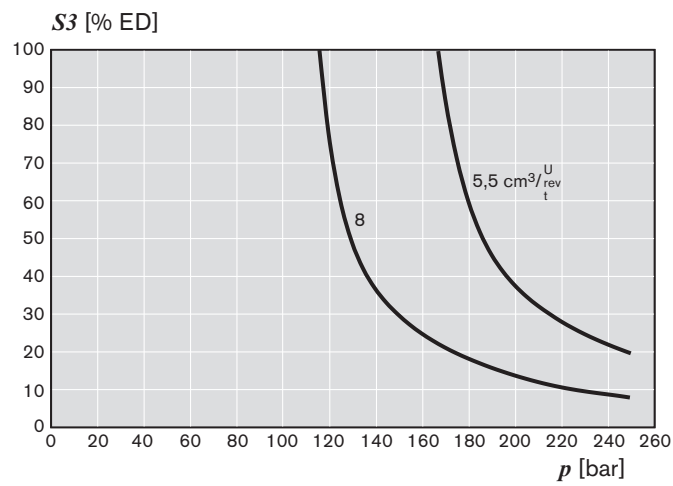
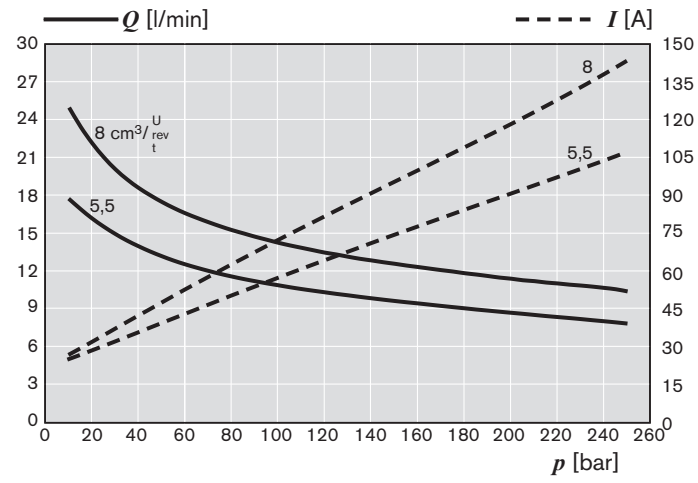

Unit dimensions

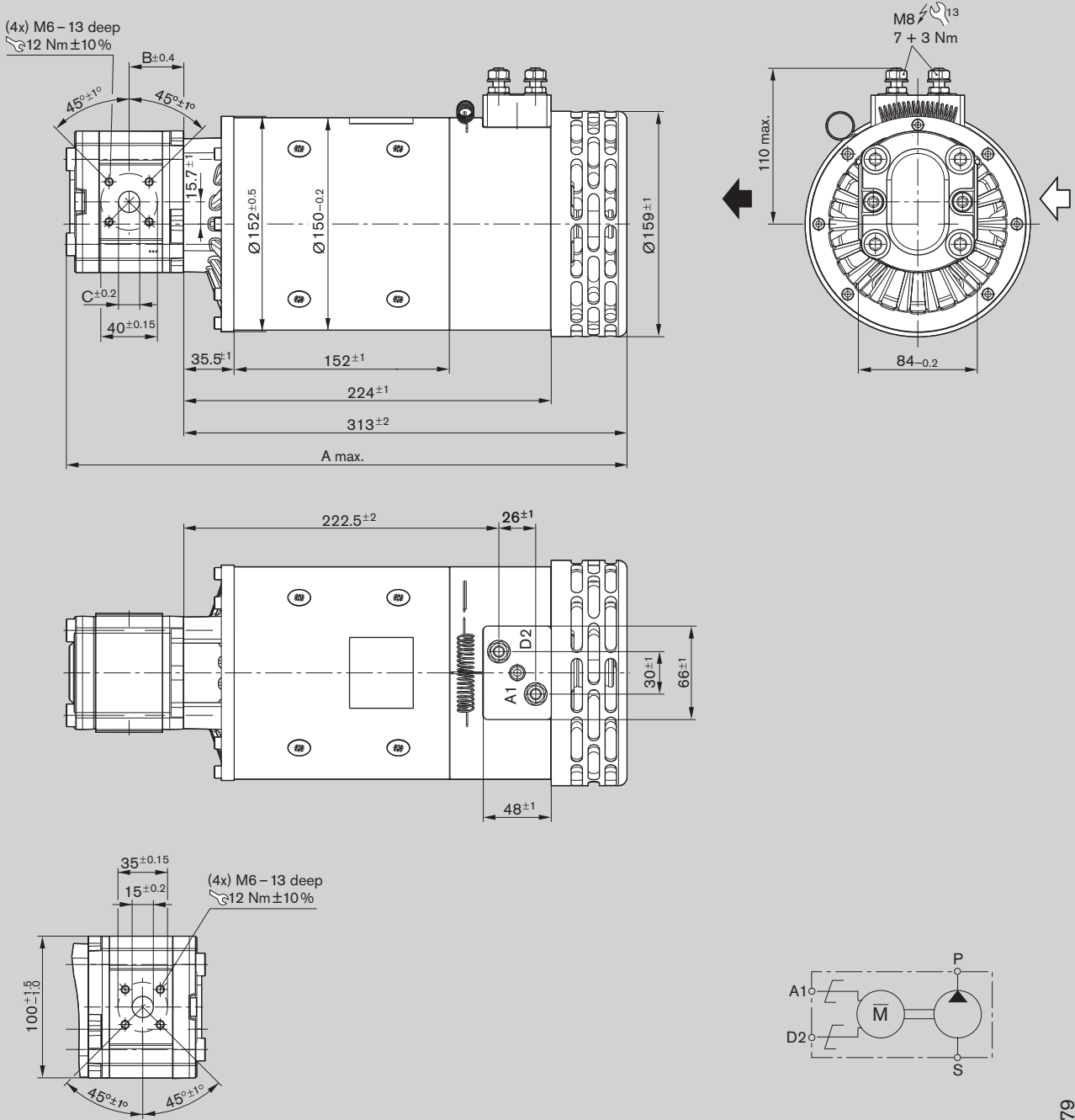

A 541 021 379

Type of protection:

Motor case IP 20

Ports IP 00

Ordering code	Displacement $V \text{ [cm}^3/\text{rev]}$	Dimension [mm]			Weight [kg]	Part number
		A	B	C		
EHP48PRL20F005-20A1341N0	5.5	399	38.6	15	20.4	<b>0 541 300 079</b>



**Characteristics  
for A 541 021 379**

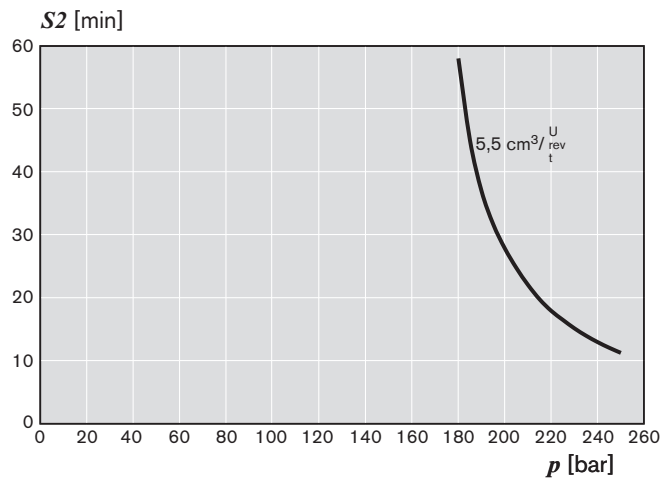
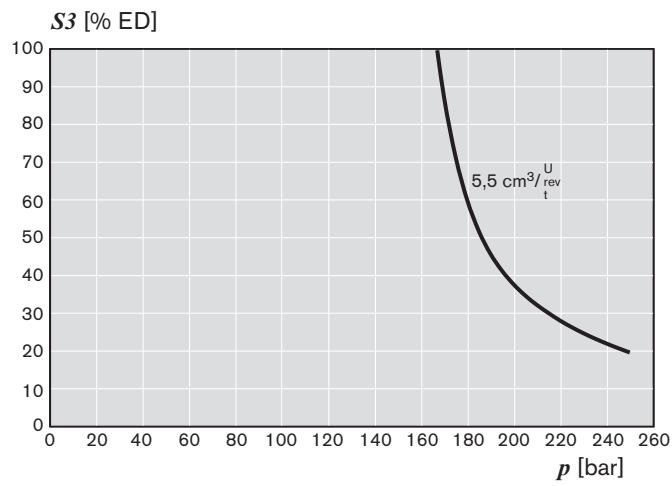
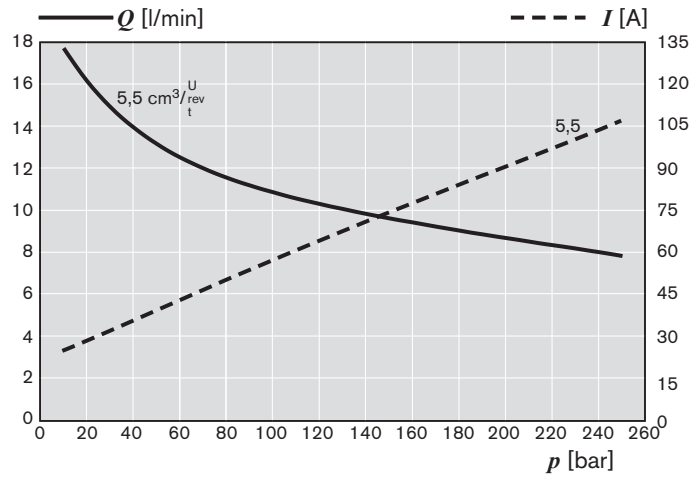

Unit dimensions

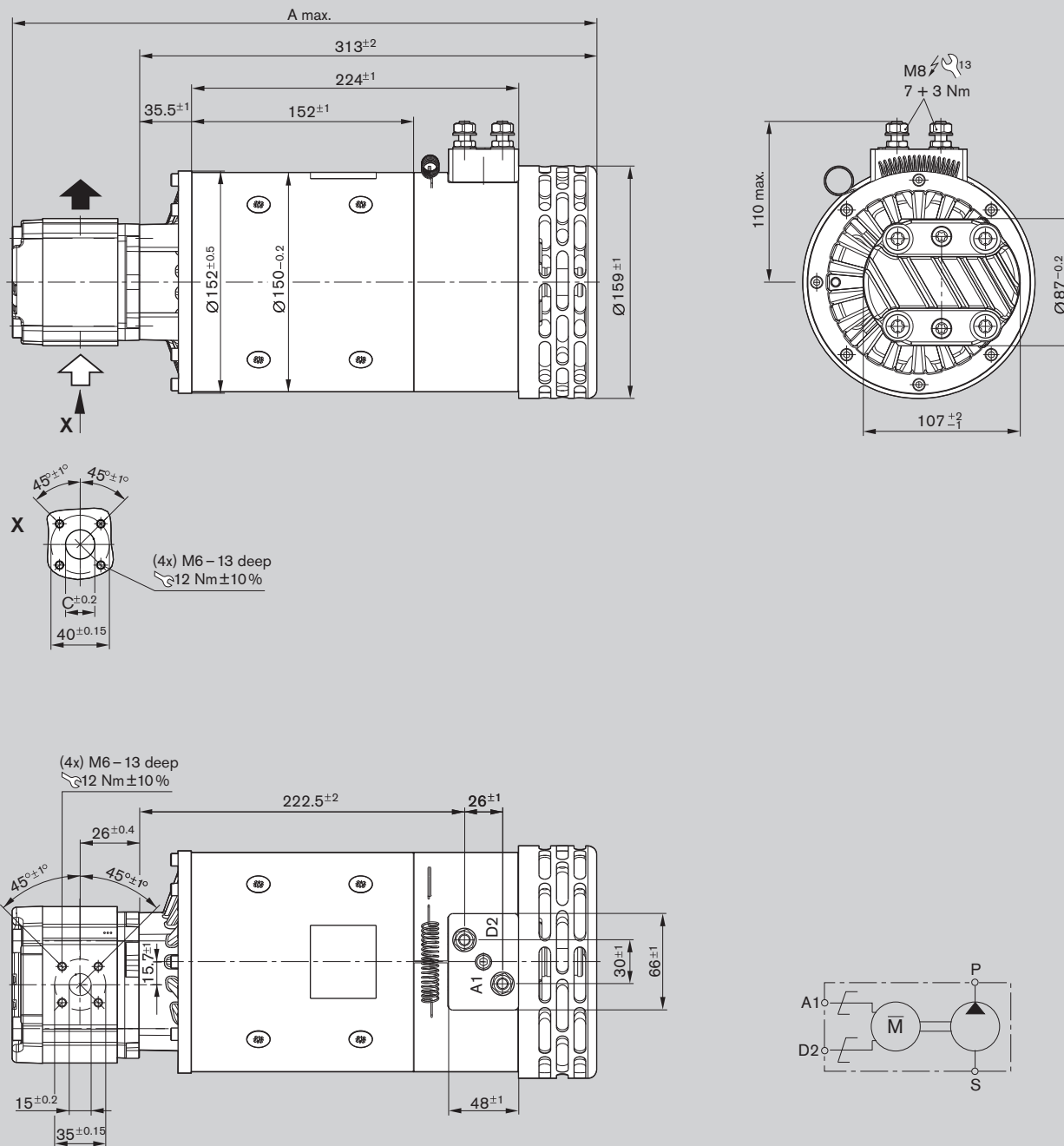

A 541 021 366

Type of protection:

Motor case IP 20

Ports IP 00

Ordering code	Displacement $V \text{ [cm}^3/\text{rev]}$	Dimension [mm]			Weight [kg]	Part number
		A	B	C		
EHP48PRL20S008-20C1339N0	8.0	403	40.7	20	20.6	<b>0 541 400 078</b>

**Characteristics  
for A 541 021 366**

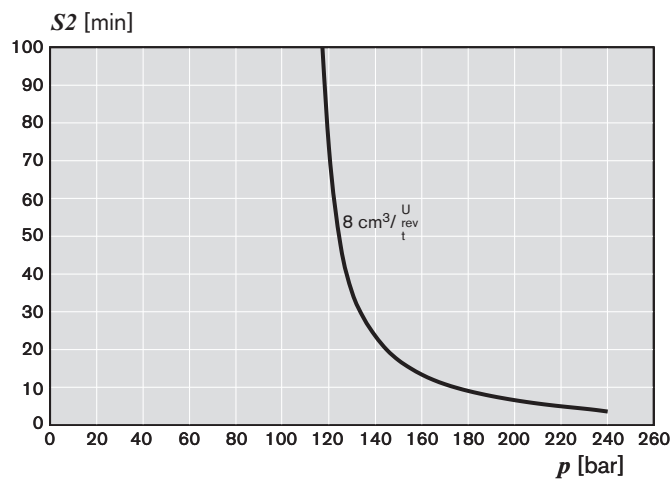
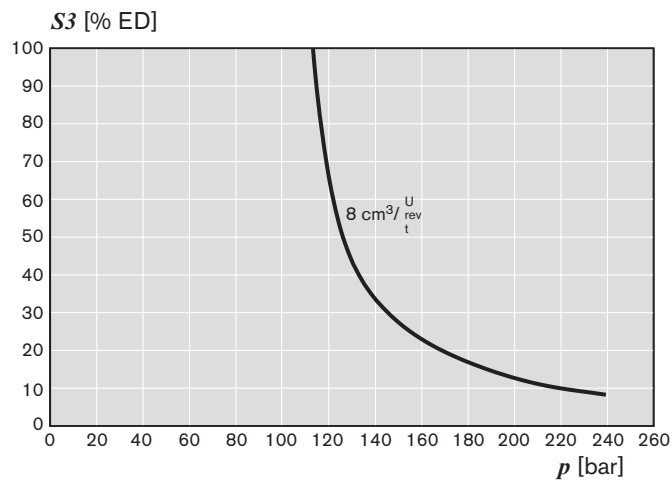
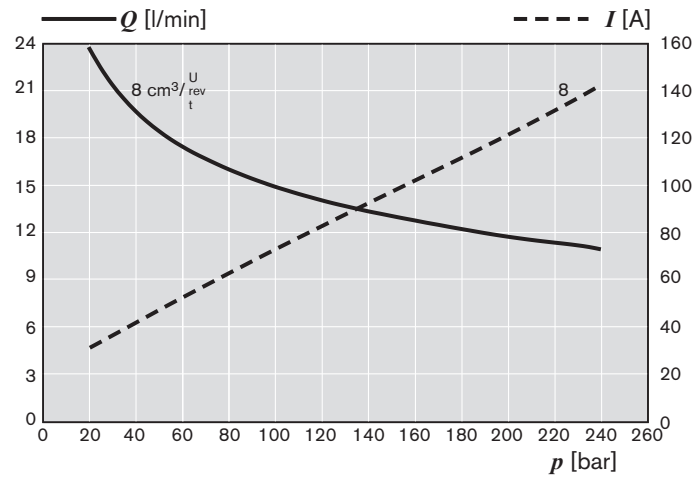

Unit dimensions

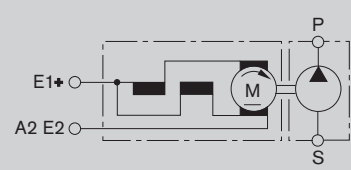
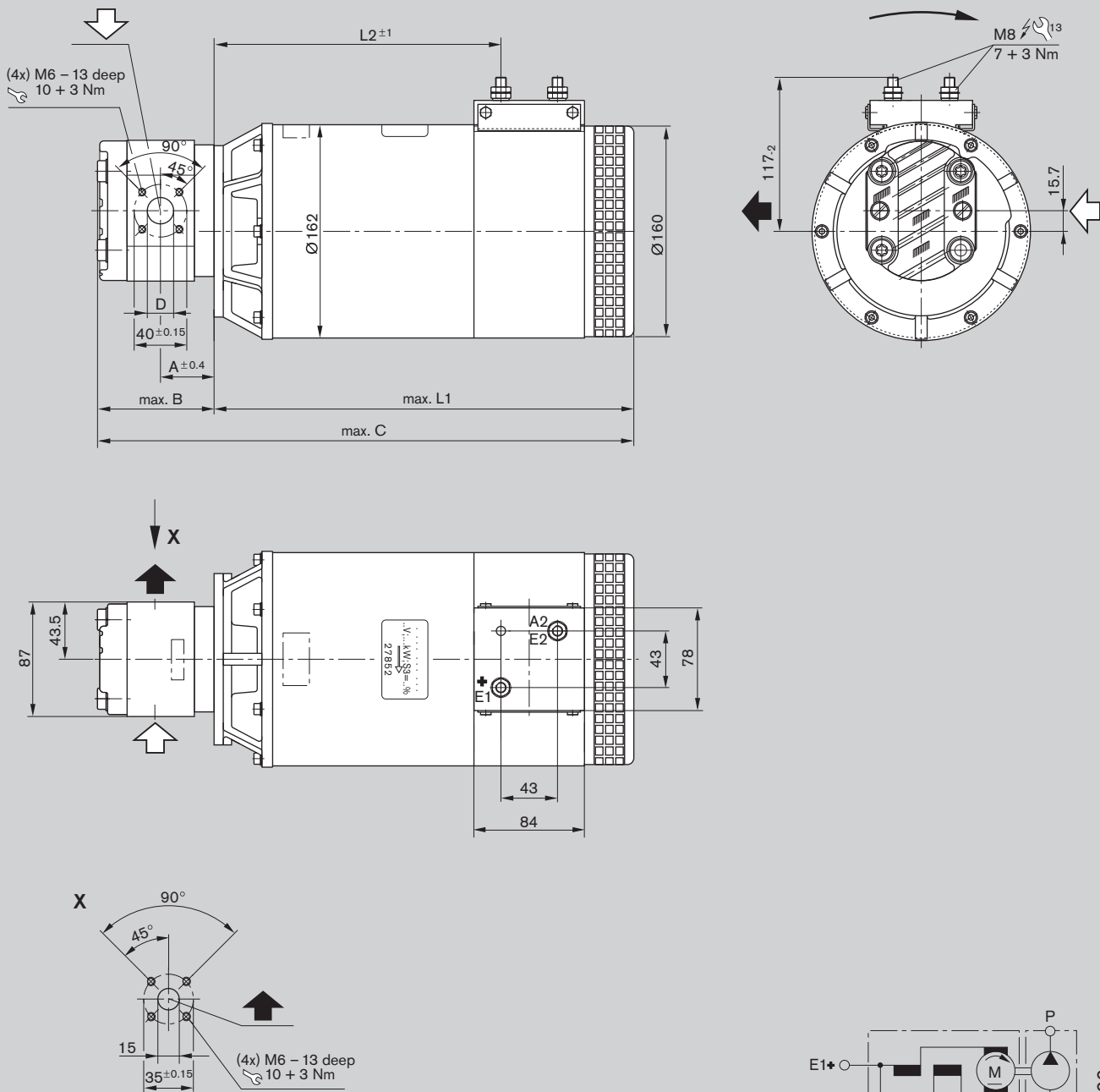

A 541 022 166

Type of protection:

Motor case IP 10  
Ports IP 00

Ordering code	Displacement $V$ [cm <sup>3</sup> /rev]	Dimension [mm]						Weight [kg]	Part number
		A	B	C	D	L1	L2		
EHP48SDL14S011-20A1173N0	11.0	45.5	94.2	461.0	20.0	366.0	262.5	26	<b>0 541 500 074</b>

**Characteristics  
for A 541 022 166**

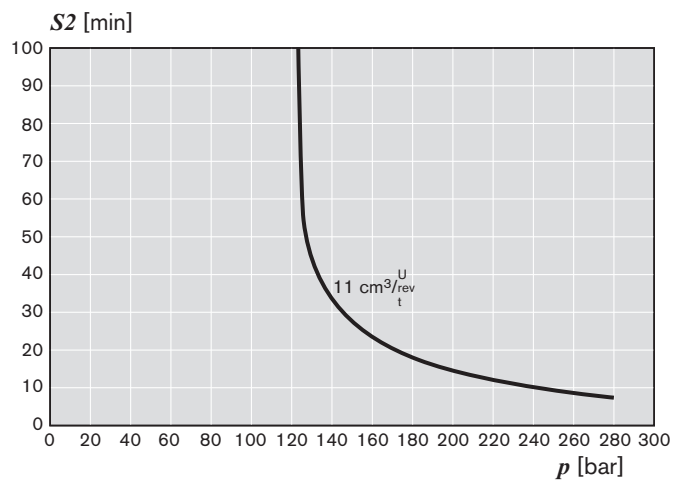
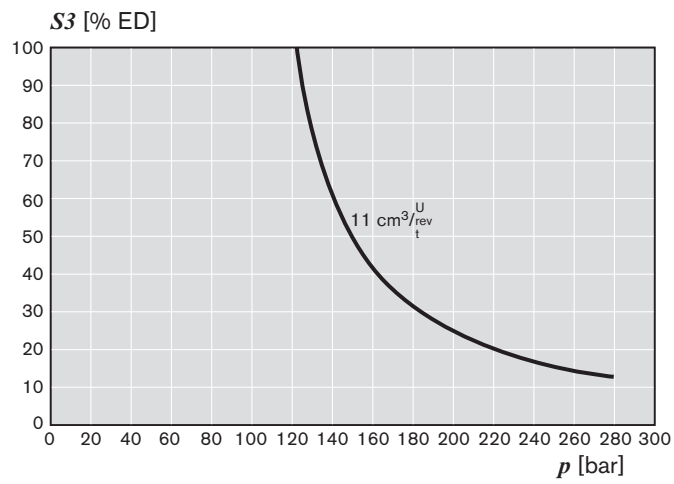
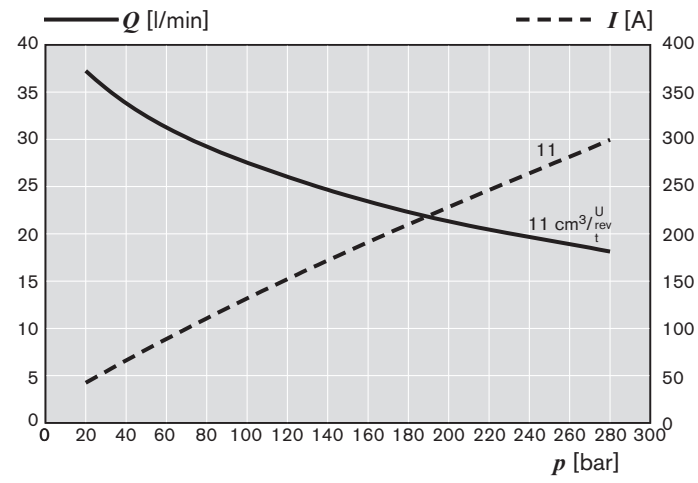

Unit dimensions

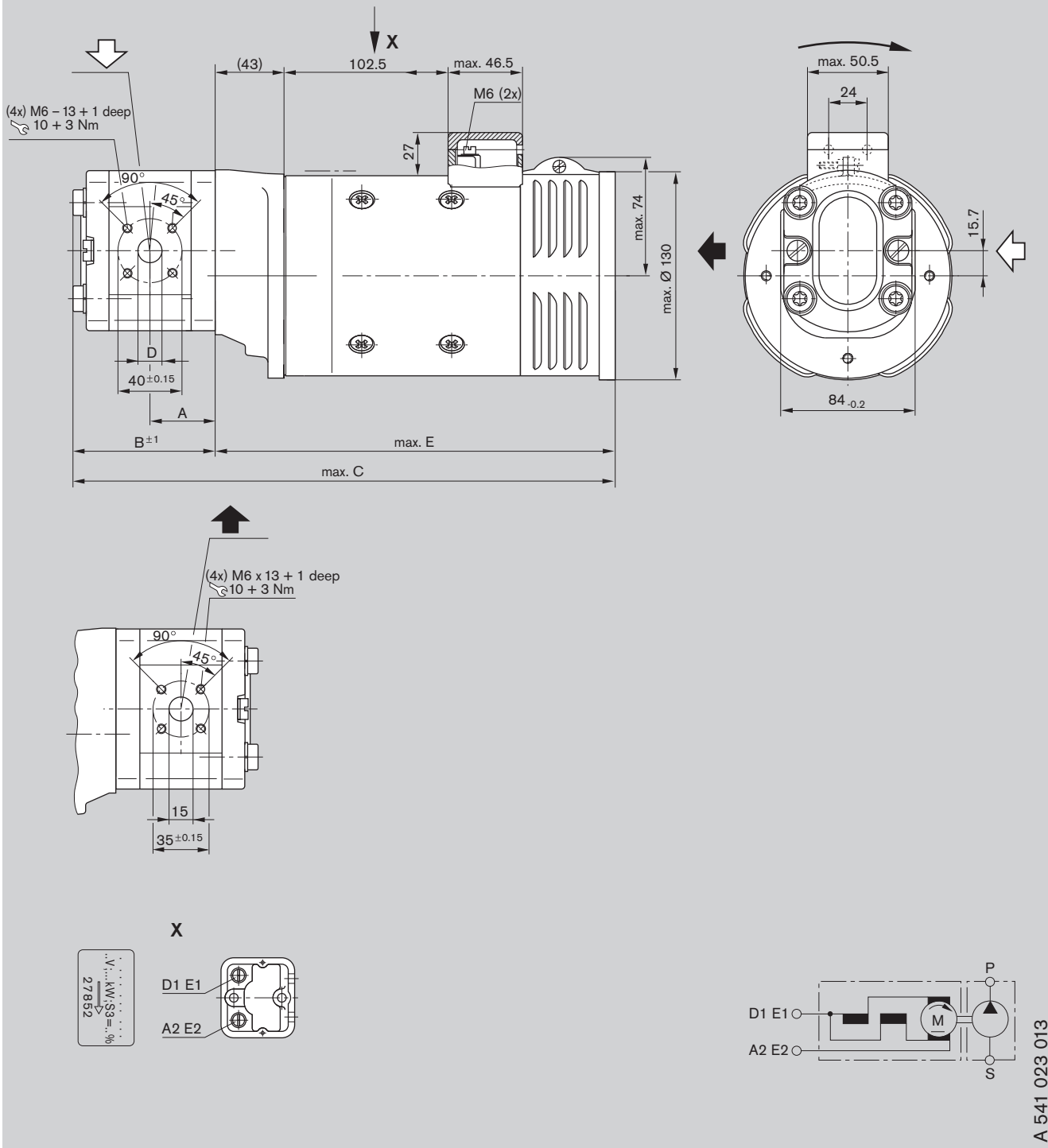

Type of protection:

Motor case IP 10

Ports IP 44

Ordering code	Displacement V [cm <sup>3</sup> /rev]	Dimension [mm]					Weight [kg]	Part number
		A	B	C	D	E		
EHP72KDO14F005-20A1003N0	5.5	38.6	85.0	336.0	15.0	250.0	15.0	<b>0 541 300 032</b>

**Characteristics  
for A 541 023 013**

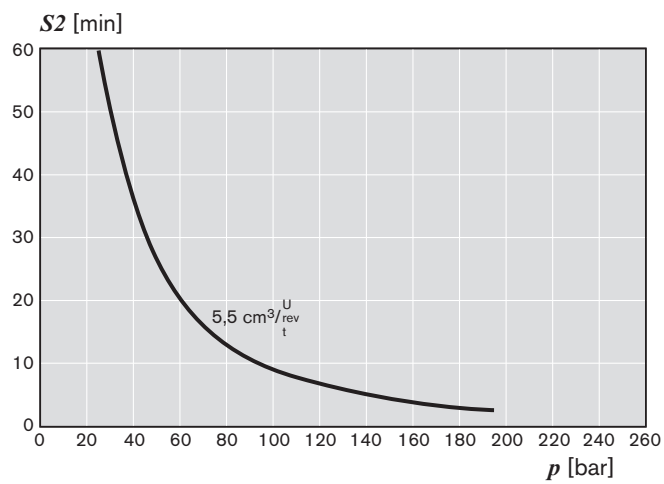
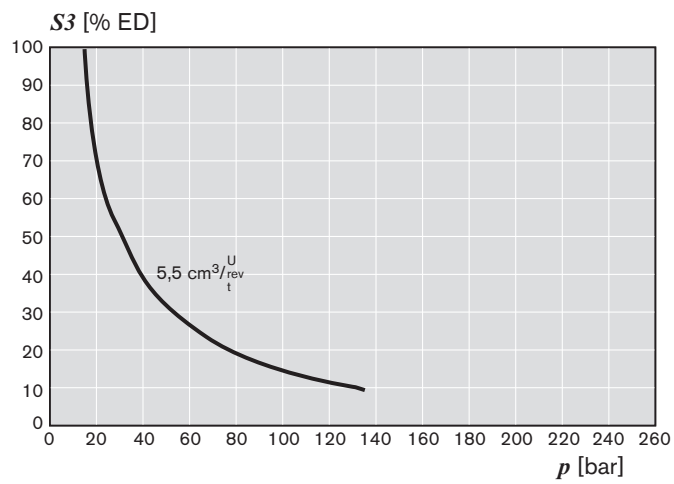
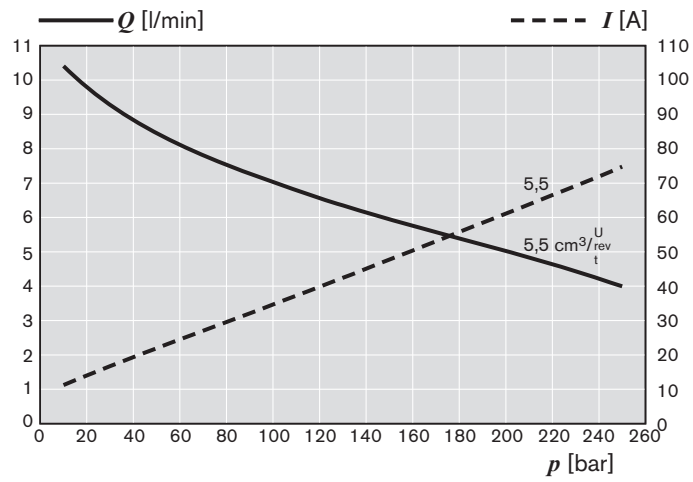

## Accessories

Fittings that can be used for square flange **20**

Gear pump flange, straight

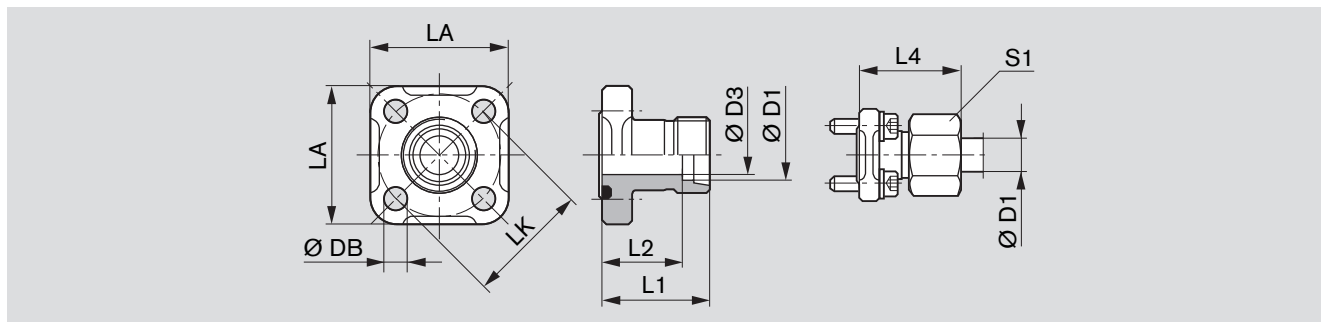

LK	D1	D3	L1	L2	L4	LA	S1	DB	Screws (metric) 4x	Seal ring	Part number	<i>p</i> [bar]
35	10L	8	30	23.0	39.0	40	19	6.4	M 6 x 22	20 x 2.5	<b>1 515 702 064</b>	315
35	12L	10	30	23.0	39.0	40	22	6.4	M 6 x 22	20 x 2.5	<b>1 515 702 065</b>	315
35	15L	12	30	23.0	38.0	40	27	6.4	M 6 x 22	20 x 2.5	<b>1 515 702 066</b>	250
40	15L	12	35	28.0	43.0	42	27	6.4	M 6 x 22	24 x 2.5	<b>1 515 702 067</b>	100
40	18L	15	35	27.5	44.0	42	32	6.4	M 6 x 22	24 x 2.5	<b>1 515 702 068</b>	100
40	22L	19	35	27.5	44.5	42	36	6.4	M 6 x 22	24 x 2.5	<b>1 515 702 069</b>	100
40	28L	24	42	27.5	44.5	42	41	6.4	M 6 x 22	24 x 2.5	<b>1 515 702 008</b>	100

Complete fittings with seal ring, metric screw set, nuts and olive.

Fittings that can be used for square flange **20**

Gear pump flange, 90° angle

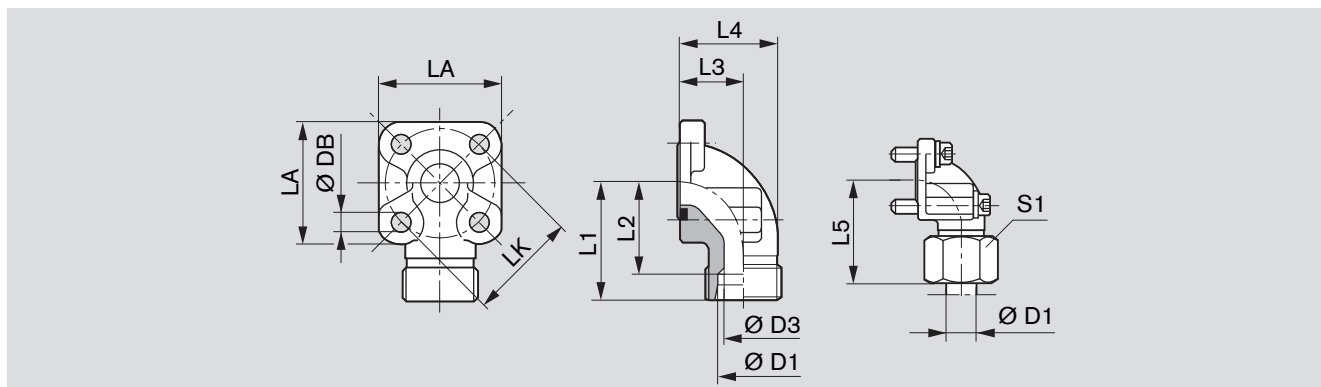

LK	D1	D3	L1	L2	L3	L4	L5	LA	S1	DB	Screws 2x	2x	Seal ring	Part number	<i>p</i> [bar]
35	10L	8	38	31.0	16.5	26.5	47.0	40	19	6.4	M 6 x 22	M 6 x 35	20 x 2.5	<b>1 515 702 070</b>	315
35	12L	10	38	31.0	16.5	26.5	47.0	40	22	6.4	M 6 x 22	M 6 x 35	20 x 2.5	<b>1 515 702 071</b>	315
35	15L	12	38	31.0	16.5	26.5	46.0	40	27	6.4	M 6 x 22	M 6 x 35	20 x 2.5	<b>1 515 702 072</b>	250
35	16S	12	38	29.5	20.0	31.0	48.0	40	30	6.4	M 6 x 22	M 6 x 40	20 x 2.5	<b>1 515 702 002</b>	315
35	18L	15	38	29.5	20.0	31.0	47.0	40	32	6.4	M 6 x 22	M 6 x 40	20 x 2.5	<b>1 545 702 006</b>	250
35	20S	16	45	34.5	25.0	38.0	56.0	40	36	6.4	M 6 x 22	M 6 x 45	20 x 2.5	<b>1 515 702 017</b>	315
40	15L	12	38	31.0	22.5	36.5	46.0	42	27	6.4	M 6 x 22	M 6 x 22	24 x 2.5	<b>1 515 702 076</b>	100
40	18L	15	38	30.5	22.5	36.5	47.0	42	32	6.4	M 6 x 22	M 6 x 22	24 x 2.5	<b>1 515 702 074</b>	100
40	20S	16	40	29.5	22.5	35.5	50.0	42	36	6.4	M 6 x 22	M 6 x 45	24 x 2.5	<b>1 515 702 011</b>	250
40	22L	19	38	30.5	22.5	36.5	47.5	42	36	6.4	M 6 x 22	M 6 x 22	24 x 2.5	<b>1 515 702 075</b>	100
40	28L	22	40	32.5	28.0	43.0	49.0	42	41	6.4	M 6 x 20	M 6 x 50	24 x 2.5	<b>1 515 702 010</b>	100
40	35L	31	41	30.5	32.0	55.0	52.0	42	50	6.4	M 6 x 22	M 6 x 60	24 x 2.5	<b>1 515 702 018</b>	100

Complete fittings with seal ring, metric screw set, nuts and olive.



Fittings that can be used for square flange **30**

## Gear pump flange, 3-hole, 90° angle

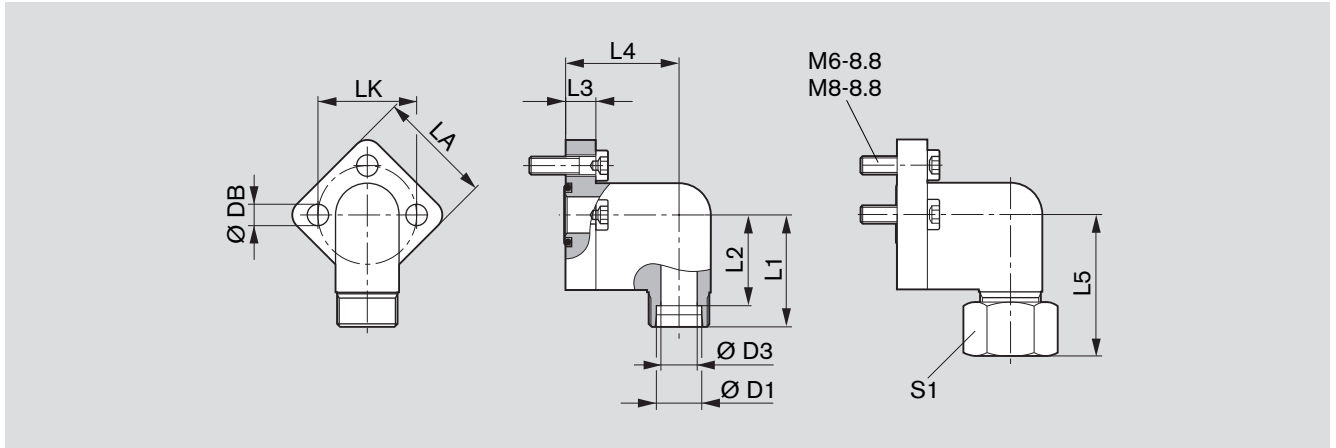

LK	D1	D3	L1	L2	L3	L4	L5	LA	S1	DB	Screws 3x	Seal ring NBR *)	Weight [kg]	Part number	p [bar]
30	12L	10	37	30.0	10	37.5	46	38	22	6.4	M 6 x 22	16 x 2.5	0.13	<b>1 515 702 146</b>	250
30	15L	12	37	30.0	10	37.5	47	38	27	6.4	M 6 x 22	16 x 2.5	0.14	<b>1 515 702 147</b>	250
30	18L	15	37	30.0	10	37.5	47	38	32	6.4	M 6 x 22	16 x 2.5	0.17	<b>1 515 702 148</b>	160
40	22L	19	43	35.5	14	41.0	53	48	36	8.4	M 8 x 30	24 x 2.5	0.29	<b>1 515 702 149</b>	160
40	28L	24	43	35.5	14	41.0	53	48	41	8.4	M 8 x 30	24 x 2.5	0.40	<b>1 515 702 150</b>	160

Complete fittings with seal ring, metric screw set, nuts and olive. \*) NBR = Perbunan®

**Note**

The permissible tightening torques can be found in our publication:  
 “General operating instructions for external gear units”  
 RE 07 012-B1.

For further information about the product electrohydraulic pump with regard to new projects, accessories and spare parts, and for general questions, please contact

**BRM-AZ.info@boschrexroth.de**

You will also find the EHP configurator in the internet, at:

**www.boschrexroth.com/azconfigurator**

<b>Rexroth</b> Bosch Group	<b>Project specification</b> <b>Electrohydraulic pump (EHP)</b>	Hydraulics DC-MA/SPP3 1/4
-------------------------------	--	---------------------------------

This project specification is intended as a guide for customer-specific projects, from the initial inquiry to the approval for a new product.

Full details under **1. Project details** are the basis for effective project management.

Detailed figures are the requirement for optimal design.

**2. Project management** is maintained internally by DC-MA/SPP3.

If any details are missing under **3. Technical data**, the Bosch Rexroth AG terms and conditions of supply and the figures stated in the catalogs and general operating conditions shall apply.

**4. Customer requirements** are to be submitted as completely as possible.

<b>1. Project details</b>	Sales person: e-mail: Telephone:						Department: Date: Customer number:				
	Customer/contact: e-mail:						Customer number: Telephone:				
	Customer vehicle/project										
	Application, project description (task of EHP in the system, e.g. implement hydraulics, emergency steering, etc.)										
		Proposal	A sample	B sample	C sample	D sample	SOP	Year 1	Year 2	Year 3	Year 4
	Deadline							/	/	/	/
	Quantity										
	€/unit										
	Additional business		<input type="checkbox"/>		Competition						
	Replacement business		<input type="checkbox"/>		Target price						
Description of product (e.g. EHP24KDG66F004-20A0653N0)											
<b>Particular technical requirements and application conditions to be stated in section 3.</b> <b>If any details are missing, compliance with the operating conditions Y 541... (see table on page 4)</b> <b>and the figures in the catalog will be assumed.</b>											
Particular features (ZA 08916) and systems (remarks, sketches, notes, specifications, drawings, etc.)											

<b>2. Project management</b>	Development location			Project category* S			N = Platform/new development A = Application development S = Series			
				* R = Fundamental R&D development V = Variant development M = Modification to series						
	Modification no.	Description		Date		Originator		Checked		
Produceability declaration required?				Project Manager:						
Yes <input type="checkbox"/> No <input type="checkbox"/>				Project number:						

<b>Rexroth</b> Bosch Group	<b>Project specification</b> <b>Electrohydraulic pump (EHP)</b>	Hydraulics DC-MA/SPP3 2/4
-------------------------------	--	---------------------------------

3. Technical data	Operating voltage of motor (volts)				
	Motor voltage type    Direct current (DC) <input type="checkbox"/> Alternating current (AC) <input type="checkbox"/>				
	Protection class Motor (IP)				
	Thermal contact (yes/no)				
	Relay (yes/no) If yes: axial or radial				
	Displacement [l/min] at working pressure [bar]	PT1	PT2	PT3	PT4
	Displacement [l/min] at maximum pressure [bar]	PT1	PT2	PT3	PT4
	Actuated time S2 in min				
	Actuated time S3 in %				
	Seals            FPM <input type="checkbox"/> NBR <input type="checkbox"/> HNBR <input type="checkbox"/> Radial shaft seal ring FPM/otherwise NBR <input type="checkbox"/>				
	Multiple pumps	Tang (light through drive) <input type="checkbox"/>			
		Splined shaft (heavy through drive) <input type="checkbox"/>			
		Separation of medium <input type="checkbox"/>			
		Common suction port <input type="checkbox"/>			
	Auxiliary function	PRV adjustment	±	bar at	l/min
		SRV adjustment	±	l/min	
		Residual current, external <input type="checkbox"/>		Residual current, internal	<input type="checkbox"/>
		Electrical connection	Prop. PRV 12 V <input type="checkbox"/>	24 V <input type="checkbox"/>	
		Connector	AMP Junior Timer (C4) <input type="checkbox"/>	DEUTSCH (K40) <input type="checkbox"/>	
	Particular notes (e.g. surface protection ...)				
Other (load complex etc.)					
Medium temperature	min	°C	max	°C	
Ambient temperature	min	°C	max	°C	
Operating medium					
Viscosity range					
Cleanliness level					
Filter grade	β	≧	– Suction filter		
	β	≧	– Pressure filter		
Ambient conditions (e.g. dust, spray water)					
Additional stress					
Noise requirements					
Installation position					
Interfaces					

<b>Rexroth</b> Bosch Group	<b>Project specification</b> <b>Electrohydraulic pump (EHP)</b>	Hydraulics DC-MA/SPP3 3/4
-------------------------------	--	---------------------------------

4. Customer demands	Legislation, standards	
	Patents, licenses	
	Additional customer demands (e.g. documentation, modification announcements, QM system, APQG, ...)	
	Safety functions or limitations	
	Acceptance	Without testing <input type="checkbox"/> Testing at customer <input type="checkbox"/> BR acceptance <input type="checkbox"/> (subject to charge) Initial sample test report <input type="checkbox"/> Volume Additional examination Additional documentation
	Certificate	
	Terms of delivery	
	Labeling	
	Packaging	Differing from standard packaging <input type="checkbox"/> Lattice box (reusable, EU only) <input type="checkbox"/> SLC (= small load carrier, reusable, EU only) <input type="checkbox"/> Wooden crate (disposable, sea freight only) <input type="checkbox"/> Non-reusable packaging (rest of world) <input type="checkbox"/> Customer wish
	Customer specification	
	Prototype version	
	Recycling	
	Service agreement	
	Repair	
	Warranty	
	Service life	Hours <span style="margin-left: 150px;">Load cycles</span>
Always state load complex with service life requirement (cf. example)		
<p><math>p_1</math> max. continuous pressure  <math>p_2</math> max. intermittent pressure  <math>p_3</math> max. peak pressure</p>		

Date, Signature of issuing party	Date, Signature of customer	Date, Signature of DC-MA/SPP3
----------------------------------	-----------------------------	-------------------------------

<b>Rexroth</b> Bosch Group	<b>Project specification</b> <b>Electrohydraulic pump (EHP)</b>	Hydraulics DC-MA/SPP3 3/4
-------------------------------	--	---------------------------------

## Operating conditions

EHP	Y 541 ... ... or quotation drawing
Information Tightening torque	Y 510 202 040

Remarks:

Bosch Rexroth AG  
Hydraulics  
AußenzahnradEinheiten  
Robert-Bosch-Straße 2  
D-71701 Schwieberdingen  
Telefon +49 (0) 711-811 10 63  
Telefax +49 (0) 711-811 17 98  
brm-az.info@boschrexroth.de  
www.boschrexroth.com/brm

© This document, as well as the data, specifications and other information set forth in it, are the exclusive property of Bosch Rexroth AG. It may not be reproduced or given to third parties without its consent. The data specified above only serve to describe the product. No statements concerning a certain condition or suitability for a certain application can be derived from our information. The information given does not release the user from the obligation of own judgment and verification. It must be remembered that our products are subject to a natural process of wear and aging.